

# DENON

UNIVERSAL AUDIO/VIDEO PLAYER

# DBP-1611UD

Owner's Manual

Manuel de l'Utilisateur

Manual del usuario

**Simple version**  
Version simplifiée  
Versión sencilla





**Basic version**  
Version basique  
Versión básica





**Advanced version**  
Version avancée  
Versión avanzada



**Information**  
"Part names and functions"  
( page 41)

**Informations**  
"Nomenclature et fonctions"  
( page 41)

**Información**  
"Nombres y funciones de las piezas" ( página 41)





SAFETY PRECAUTIONS



**CAUTION**  
**RISK OF ELECTRIC SHOCK**  
**DO NOT OPEN**



**CAUTION:**  
**TO REDUCE THE RISK OF ELECTRIC SHOCK, DO NOT REMOVE COVER (OR BACK). NO USER-SERVICEABLE PARTS INSIDE. REFER SERVICING TO QUALIFIED SERVICE PERSONNEL.**

The lightning flash with arrowhead symbol, within an equilateral triangle, is intended to alert the user to the presence of uninsulated "dangerous voltage" within the product's enclosure that may be of sufficient magnitude to constitute a risk of electric shock to persons.

The exclamation point within an equilateral triangle is intended to alert the user to the presence of important operating and maintenance (servicing) instructions in the literature accompanying the appliance.

**WARNING:**  
**TO REDUCE THE RISK OF FIRE OR ELECTRIC SHOCK, DO NOT EXPOSE THIS APPLIANCE TO RAIN OR MOISTURE.**

**CAUTION:**  
**USE OF CONTROLS OR ADJUSTMENTS OR PERFORMANCE OF PROCEDURES OTHER THAN THOSE SPECIFIED HEREIN MAY RESULT IN HAZARDOUS RADIATION EXPOSURE. THIS PRODUCT SHOULD NOT BE ADJUSTED OR REPAIRED BY ANYONE EXCEPT PROPERLY QUALIFIED SERVICE PERSONNEL**

Laser Class (IEC 60825-1:2001)

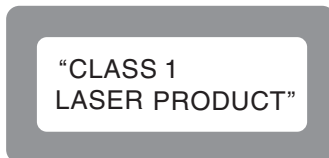

# IMPORTANT SAFETY INSTRUCTIONS

1. Read these instructions.
2. Keep these instructions.
3. Heed all warnings.
4. Follow all instructions.
5. Do not use this apparatus near water.
6. Clean only with dry cloth.
7. Do not block any ventilation openings. Install in accordance with the manufacturer's instructions.
8. Do not install near any heat sources such as radiators, heat registers, stoves, or other apparatus (including amplifiers) that produce heat.
9. Do not defeat the safety purpose of the polarized or grounding-type plug. A polarized plug has two blades with one wider than the other. A grounding type plug has two blades and a third grounding prong. The wide blade or the third prong are provided for your safety. If the provided plug does not fit into your outlet, consult an electrician for replacement of the obsolete outlet.
10. Protect the power cord from being walked on or pinched particularly at plugs, convenience receptacles, and the point where they exit from the apparatus.
11. Only use attachments/accessories specified by the manufacturer.
12. Use only with the cart, stand, tripod, bracket, or table specified by the manufacturer, or sold with the apparatus. When a cart is used, use caution when moving the cart/apparatus combination to avoid injury from tip-over.
13. Unplug this apparatus during lightning storms or when unused for long periods of time.
14. Refer all servicing to qualified service personnel. Servicing is required when the apparatus has been damaged in any way, such as power-supply cord or plug is damaged, liquid has been spilled or objects have fallen into the apparatus, the apparatus has been exposed to rain or moisture, does not operate normally, or has been dropped.
15. Batteries shall not be exposed to excessive heat such as sunshine, fire or the like.



**CAUTION:**

To completely disconnect this product from the mains, disconnect the plug from the wall socket outlet.

The mains plug is used to completely interrupt the power supply to the unit and must be within easy access by the user.

**PRECAUTION:**

Pour déconnecter complètement ce produit du courant secteur, débranchez la prise de la prise murale.

La prise secteur est utilisée pour couper complètement l'alimentation de l'appareil et l'utilisateur doit pouvoir y accéder facilement.

**PRECAUCIÓN:**

Para desconectar completamente este producto de la alimentación eléctrica, desconecte el enchufe del enchufe de la pared.

El enchufe de la alimentación eléctrica se utiliza para interrumpir por completo el suministro de alimentación eléctrica a la unidad y debe de encontrarse en un lugar al que el usuario tenga fácil acceso.

FCC INFORMATION (For US customers)

**1. COMPLIANCE INFORMATION**

Product Name: Universal Audio / Video player

Model Number: DBP-1611UD

This product complies with Part 15 of the FCC Rules. Operation is subject to the following two conditions: (1) this product may not cause harmful interference, and (2) this product must accept any interference received, including interference that may cause undesired operation.

Denon Electronics (USA), LLC

(a D & M Holdings Company)

100 Corporate Drive

Mahwah, NJ 07430-2041

Tel. (800) 497-8921

**2. IMPORTANT NOTICE: DO NOT MODIFY THIS PRODUCT**

This product, when installed as indicated in the instructions contained in this manual, meets FCC requirements. Modification not expressly approved by DENON may void your authority, granted by the FCC, to use the product.

**3. NOTE**

This product has been tested and found to comply with the limits for a Class B digital device, pursuant to Part 15 of the FCC Rules. These limits are designed to provide reasonable protection against harmful interference in a residential installation.

This product generates, uses and can radiate radio frequency energy and, if not installed and used in accordance with the instructions, may cause harmful interference to radio communications. However, there is no guarantee that interference will not occur in a particular installation. If this product does cause harmful interference to radio or television reception, which can be determined by turning the product OFF and ON, the user is encouraged to try to correct the interference by one or more of the following measures:

- Reorient or relocate the receiving antenna.
- Increase the separation between the equipment and receiver.
- Connect the product into an outlet on a circuit different from that to which the receiver is connected.
- Consult the local retailer authorized to distribute this type of product or an experienced radio/TV technician for help.

**For Canadian customers:**

This Class B digital apparatus complies with Canadian ICES-003.

Cet appareil numérique de la classe B est conforme à la norme NMB-003 du Canada.

☐ NOTES ON USE / OBSERVATIONS RELATIVES A L'UTILISATION / NOTAS SOBRE EL USO

WARNINGS	AVERTISSEMENTS	ADVERTENCIAS
<ul style="list-style-type: none"> <li>• Avoid high temperatures. Allow for sufficient heat dispersion when installed in a rack.</li> <li>• Handle the power cord carefully. Hold the plug when unplugging the cord.</li> <li>• Keep the unit free from moisture, water, and dust.</li> <li>• Unplug the power cord when not using the unit for long periods of time.</li> <li>• Do not obstruct the ventilation holes.</li> <li>• Do not let foreign objects into the unit.</li> <li>• Do not let insecticides, benzene, and thinner come in contact with the unit.</li> <li>• Never disassemble or modify the unit in any way.</li> <li>• Ventilation should not be impeded by covering the ventilation openings with items, such as newspapers, tablecloths or curtains.</li> <li>• Naked flame sources such as lighted candles should not be placed on the unit.</li> <li>• Observe and follow local regulations regarding battery disposal.</li> <li>• Do not expose the unit to dripping or splashing fluids.</li> <li>• Do not place objects filled with liquids, such as vases, on the unit.</li> <li>• Do not handle the mains cord with wet hands.</li> <li>• When the switch is in the OFF position, the equipment is not completely switched off from MAINS.</li> <li>• The equipment shall be installed near the power supply so that the power supply is easily accessible.</li> </ul>	<ul style="list-style-type: none"> <li>• Eviter des températures élevées. Tenir compte d'une dispersion de chaleur suffisante lors de l'installation sur une étagère.</li> <li>• Manipuler le cordon d'alimentation avec précaution. Tenir la prise lors du débranchement du cordon.</li> <li>• Protéger l'appareil contre l'humidité, l'eau et la poussière.</li> <li>• Débrancher le cordon d'alimentation lorsque l'appareil n'est pas utilisé pendant de longues périodes.</li> <li>• Ne pas obstruer les trous d'aération.</li> <li>• Ne pas laisser des objets étrangers dans l'appareil.</li> <li>• Ne pas mettre en contact des insecticides, du benzène et un diluant avec l'appareil.</li> <li>• Ne jamais démonter ou modifier l'appareil d'une manière ou d'une autre.</li> <li>• Ne pas recouvrir les orifices de ventilation avec des objets tels que des journaux, nappes ou rideaux. Cela entraverait la ventilation.</li> <li>• Ne jamais placer de flamme nue sur l'appareil, notamment des bougies allumées.</li> <li>• Veillez à respecter les lois en vigueur lorsque vous jetez les piles usagées.</li> <li>• L'appareil ne doit pas être exposé à l'eau ou à l'humidité.</li> <li>• Ne pas poser d'objet contenant du liquide, par exemple un vase, sur l'appareil.</li> <li>• Ne pas manipuler le cordon d'alimentation avec les mains mouillées.</li> <li>• Lorsque l'interrupteur est sur la position OFF, l'appareil n'est pas complètement déconnecté du SECTEUR (MAINS).</li> <li>• L'appareil sera installé près de la source d'alimentation, de sorte que cette dernière soit facilement accessible.</li> </ul>	<ul style="list-style-type: none"> <li>• Evite altas temperaturas. Permite la suficiente dispersión del calor cuando está instalado en la consola.</li> <li>• Maneje el cordón de energía con cuidado. Sostenga el enchufe cuando desconecte el cordón de energía.</li> <li>• Mantenga el equipo libre de humedad, agua y polvo.</li> <li>• Desconecte el cordón de energía cuando no utilice el equipo por mucho tiempo.</li> <li>• No obstruya los orificios de ventilación.</li> <li>• No deje objetos extraños dentro del equipo.</li> <li>• No permita el contacto de insecticidas, gasolina y diluyentes con el equipo.</li> <li>• Nunca desarme o modifique el equipo de ninguna manera.</li> <li>• La ventilación no debe quedar obstruida por haberse cubierto las aperturas con objetos como periódicos, manteles o cortinas.</li> <li>• No deberán colocarse sobre el aparato fuentes inflamables sin protección, como velas encendidas.</li> <li>• A la hora de deshacerse de las pilas, respete la normativa para el cuidado del medio ambiente.</li> <li>• No exponer el aparato al goteo o salpicaduras cuando se utilice.</li> <li>• No colocar sobre el aparato objetos llenos de líquido, como jarros.</li> <li>• No maneje el cable de alimentación con las manos mojadas.</li> <li>• Cuando el interruptor está en la posición OFF, el equipo no está completamente desconectado de la alimentación MAINS.</li> <li>• El equipo se instalará cerca de la fuente de alimentación de manera que resulte fácil acceder a ella.</li> </ul>

☐ CAUTIONS ON INSTALLATION  
PRÉCAUTIONS D'INSTALLATION  
EMPLAZAMIENTO DE LA INSTALACIÓN

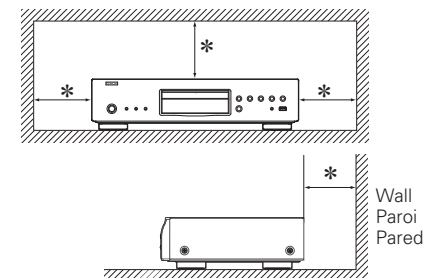

**\* For proper heat dispersal, do not install this unit in a confined space, such as a bookcase or similar enclosure.**

- More than 0.1 m (4 in.) is recommended.
- Do not place any other equipment on this unit.

**\* Pour permettre la dissipation de chaleur requise, n'installez pas cette unité dans un espace confiné tel qu'une bibliothèque ou un endroit similaire.**

- Une distance de plus de 0.1 m (4 po) est recommandée.
- Ne placez aucun matériel sur cet appareil.

**\* Para la dispersión del calor adecuadamente, no instale este equipo en un lugar confinado tal como una librería o unidad similar.**

- Se recomienda dejar más de 0.1 m (4 pulg.) alrededor.
- No coloque ningún otro equipo sobre la unidad.

# Getting started

Thank you for purchasing this DENON product. To ensure proper operation, please read these owner's manual carefully before using the product. After reading them, be sure to keep them for future reference.

## Contents

<b>Getting started</b> .....	1
Accessories .....	1
About this manual .....	1
Features .....	2
Cautions on handling .....	2
Cautions on handling for 3D video .....	2
<b>Simple version (Simple setup guide)</b> .....	3
<b>Basic version</b> .....	8
<b>Basic connections</b> .....	9
Important information .....	9
Connecting an AV receiver .....	9
Connecting a TV .....	11
Connecting a 2-channel audio amplifier .....	12
Connecting to a digital recording device .....	12
<b>Playback (Basic operation)</b> .....	13
About playback information .....	13
Playing BD and DVD-Video .....	14
Playing Super Audio CD .....	15
Playing DVD-Audio .....	16
Playing CD .....	16
Operations enabled during playback .....	17
<b>Basic settings</b> .....	21
Changing the brightness of the display (Dimmer control) .....	21
Playing high-quality audio (Pure direct function) .....	21
HDMI control functions .....	21
Video resolution .....	22
Adjusting the picture quality (Picture control) .....	23
Mode setting .....	24

<b>Advanced version</b> .....	25
<b>Advanced connections</b> .....	26
Connecting to a USB memory device .....	26
Connecting to a network .....	26
<b>Playback (Advanced operation)</b> .....	28
Home menu screen .....	28
<b>How to make detailed settings</b> .....	32
Menu map .....	32
GUI menu operation .....	33
General Setting .....	34
Video Setting .....	37
Audio Setting .....	38
System Information .....	39

<b>Information</b> .....	40
<b>Part names and functions</b> .....	41
Front panel .....	41
Display .....	41
Rear panel .....	42
Remote control .....	43
<b>About media</b> .....	45
Playable media .....	45
Cautions on using media .....	48
<b>Other information</b> .....	49
About digital signal audio output .....	49
Trademark information .....	50
Explanation of Terms .....	51
<b>Troubleshooting</b> .....	53
<b>Specifications</b> .....	56

## Accessories

Check that the following parts are supplied with the product.

- ① Owner's manual ..... 1
- ② Warranty (for North America model only)..... 1
- ③ Service station list ..... 1
- ④ Power cord (Cord length: Approx. 6.6ft / 2.0 m) ..... 1
- ⑤ Remote control (RC-1151)..... 1
- ⑥ R6/AA batteries ..... 2
- ⑦ Audio and Video cable (Cord length: Approx. 4.9ft / 1.5 m) .... 1



## About this manual

### ❑ Operation buttons

The operations described in this manual are based mainly on use of the remote control buttons.

### ❑ Symbols



This symbol indicates a reference page on which related information is described.



This symbol indicates a supplementary information and tips for operations.



This symbol indicates points to remember operations or function limitations.

### ❑ Illustrations

Note that the illustrations in these instructions may differ from the actual unit for explanation purposes.

## Features

### A Universal Audio/Video player that plays Super Audio CD and DVD-Audio formats

The unit supports a variety of media and enables video and audio playback of your disc libraries with high quality (☞ page 45 "Playable media").

### Supporting the Network operations

- When the unit is connected to the Internet, Netflix and YouTube service can be used.
- Music, photos, video files stored on the device connected via the network can be played.
- When the unit is connected to the Internet, privileged video can be downloaded from the Internet site to the built-in memory to enjoy BD-LIVE™ (☞ page 26 "Connecting to a network").

### 3D video playback

When the unit is connected to a 3D enabled TV with a high speed HDMI cable, you can enjoy 3D video.

### Direct Mechanical Ground Construction, supporting high-quality HD sound and video by suppressing vibration

The disc mechanism that causes vibration is arranged at the center of the unit to transmit vibration out through the base, enabling video and audio playback of high quality.

### Independent Block Construction for playing video and audio signals with high fidelity

The electronic circuits are separated to prevent electronic and electromagnetic noise caused by various electronic signals in the unit.

### GUI equipped for good operability and visibility

This unit is equipped with an easy to see "Graphical User Interface" that uses menu displays and levels. The use of level displays increases operability of the this unit (☞ page 33 "GUI menu operation").

### HDMI control

By connecting a television or AV receiver that supports the HDMI control function to this unit using an HDMI cable, and enabling the HDMI control settings on each device, you can control other devices from one device (☞ page 21 "HDMI control functions").

## Cautions on handling

### • Before turning the power switch on

Check once again that all connections are correct and that there are no problems with the connection cables.

- Power is supplied to some of the circuitry even when the unit is set to the standby mode. When leaving home for long periods of time, be sure to unplug the power cord from the power outlet.

### • Image persistence (image burn-in)

Do not leave still images of the disc menu, the unit menu, etc., displayed on the TV screen for long periods. This can result in image persistence (image burn-in) on the screen.

### • About condensation

If there is a major difference in temperature between the inside of the unit and the surroundings, condensation (dew) may form on the operating parts inside the unit, causing the unit not to operate properly.

If this happens, let the unit sit for an hour or two with the power turned off and wait until there is little difference in temperature before using the unit.

### • Cautions on using mobile phones

Using a mobile phone near this unit may result in noise. If that occurs, move the mobile phone away from the unit when it is in use.

### • Moving the unit

Be sure to remove a disc, turn off the power and unplug the power cord from the power outlet. Next, disconnect the connection cables to other system equipment before moving the unit.

### • About Care

- Wipe the cabinet and control panel clean with a soft cloth.
- Follow the instructions when using a chemical cleaner.
- Benzene, paint thinner or other organic solvents, as well as insecticide, may cause material changes and discoloration if brought into contact with the unit, and should, therefore, not be used.

### • Sufficiently ventilate the place of installation

If the unit is left in a room full of the smoke from cigarettes, etc., for long periods of time, the surface of the optical pickup could get dirty, in which case it will not be able to read the signals properly.

## Cautions on handling for 3D video

Before viewing 3D video, refer to the considerations described in the instruction manuals and other documents for your 3D enabled TV and 3D compatible glasses together with this manual.

- **Do not view 3D video if you have epilepsy or heart disease, if you have had photosensitivity reactions before, or when you do not feel well.**

Doing so may aggravate the symptoms.

- **When you view 3D movies, etc., take a break adequately, once per movie as a guide.**

Prolonged viewing of 3D video may cause eye strain.

- **Restrict viewing of 3D video to those aged six and over as a guide.**

Children do not respond to tiredness and discomfort expressly, so they may suddenly get sick.

When children view 3D video, parents should keep their eyes open for signs of eye strain in children.

- **Stop viewing 3D video when you see double images or you can not see 3D effects.**

Viewing 3D video continuously in these conditions may cause eye strain.

- **Stop viewing 3D video when you feel something wrong, get tired, or get sick.**

Viewing 3D video continuously in these conditions may cause poor physical condition. Take a proper break.

- **Pay attention to nearby people and objects.**

Reaching for something without a sense of distance due to 3D video or moving your body suddenly in response to a 3D video image when you take it for a real object may cause injury to nearby people or cause damages to nearby objects resulting in injury. Keep fragile objects away from your viewing area.

- **Wear your vision correction glasses or contact lens under the 3D glasses if you have nearsightedness, farsightedness, anisometropia, or astigmatism.**

Viewing 3D video without correcting your vision may cause eye strain or decreased vision.

- **Sit at a proper distance from the screen when you view 3D video.**

Sitting too close to the screen may cause eye strain or decreased vision. Sit at a distance that is recommended in the instruction manual for your TV.

# Simple version (Simple setup guide)

This section briefly describes the procedures from connecting this unit and a television or AV receiver, using an HDMI cable, to start playback after unpacking.

- ❑ Before connecting the unit, turn off the power to all devices.
- ❑ For operation of the connected devices, refer to the user manuals for each device.

**1**

## Connect

(☞ page 4)

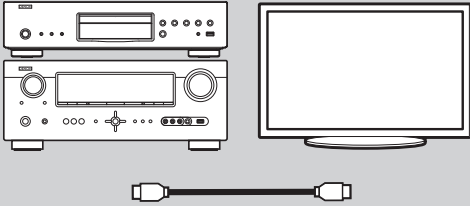

Connect this unit and a television or an AV receiver using an HDMI cable.

**2**

## Turn on power

(☞ page 5)

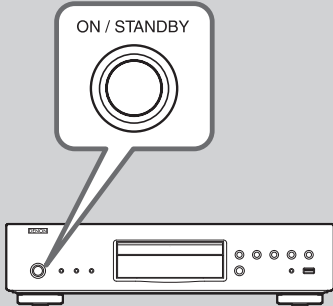

**3**

## Set up the audio

(☞ page 6)

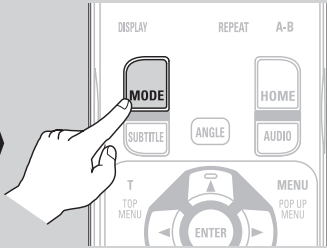

Press **MODE** to set up audio.

**4**

## Play back disc

(☞ page 7)

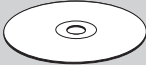

Enjoy Blu-ray Disc and DVD.

# 1 Connect

This section describes two methods for connecting this unit and a television, connecting directly or via an AV receiver. Use an appropriate method depending on the television to be used. For the connection, use an HDMI cable (sold separately).



- If the device to be connected to the unit does not support the HDMI connection, see “Basic connections” (page 9), and make connections depending upon the conditions.
- Use only HDMI (High Definition Multimedia Interface) cable that bears the HDMI logo (genuine HDMI product). Using cable without the HDMI logo (non-genuine HDMI product) may result in abnormal playback.
- When outputting Deep Color or 1080p, etc., we recommend you use “High Speed HDMI cable” or “High Speed HDMI cable with Ethernet” for enhanced high-quality playback.

## TV

This method is for connecting the unit and a television directly.

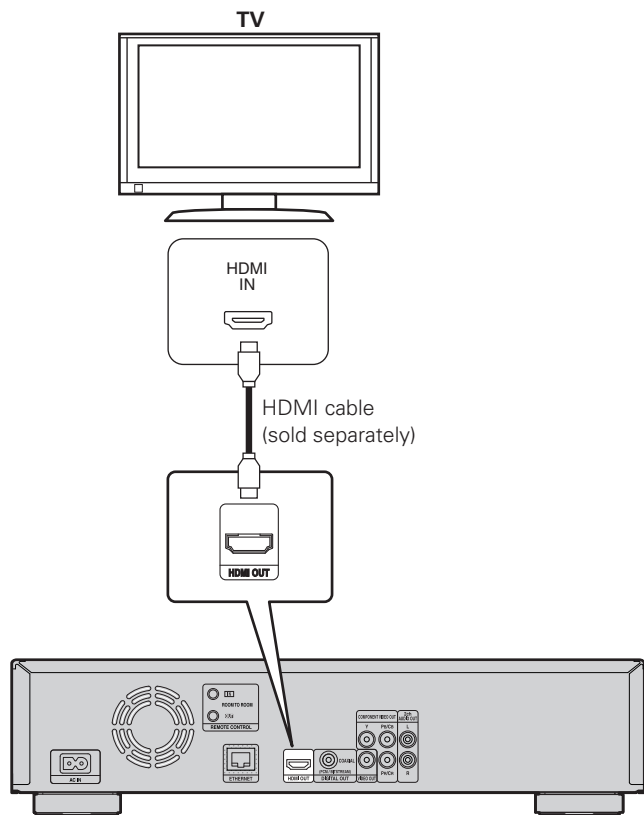

## AV receiver and TV

This method is for connecting the unit to an AV receiver.

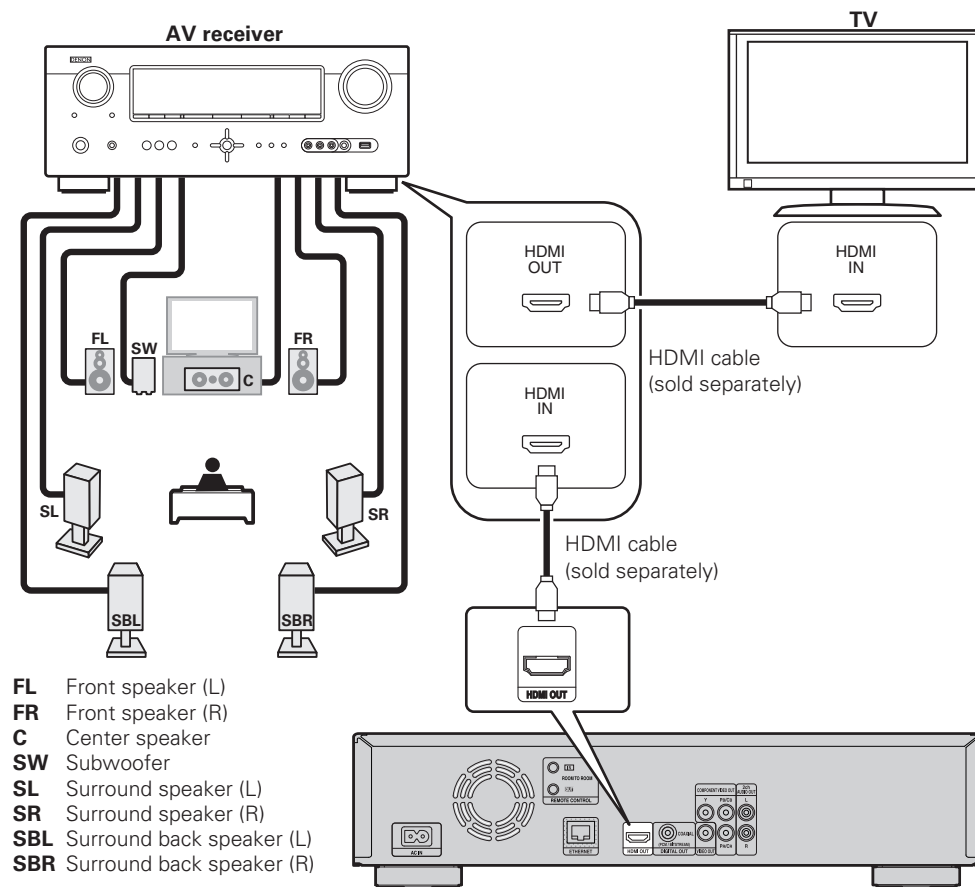



## 2 Turn on power



### Power cord

Connect the supplied power cord to the unit, and plug it into an AC outlet.

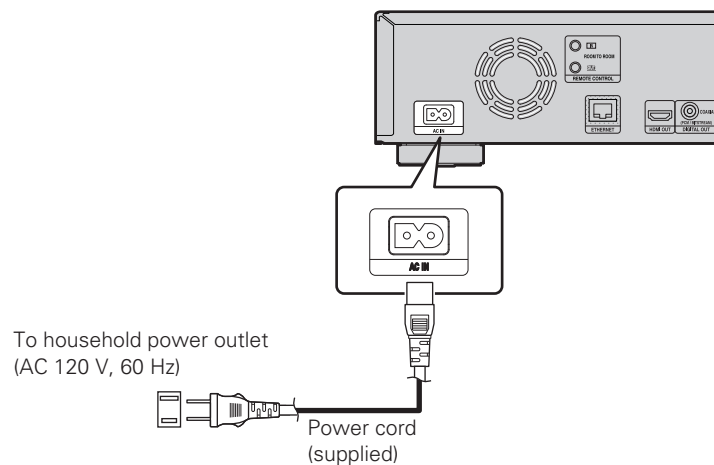

#### NOTE

- Be sure to insert the power plug firmly. Incomplete connection results in noise.
- Do not plug in the power cord until all connections have been completed.
- Do not bundle power cords together with connection cables. Doing so can result in humming or noise.

### 1 Turn on the power of the TV and AV receiver.

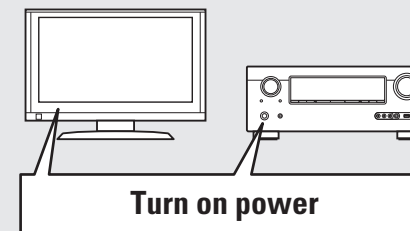

### 2 Set the TV and AV receiver source to the unit input.

### 3 Press POWER ON to turn on power to the unit.

- The power indicator flashes green and the power turns on.
- Then the power indicator remains lit in green.

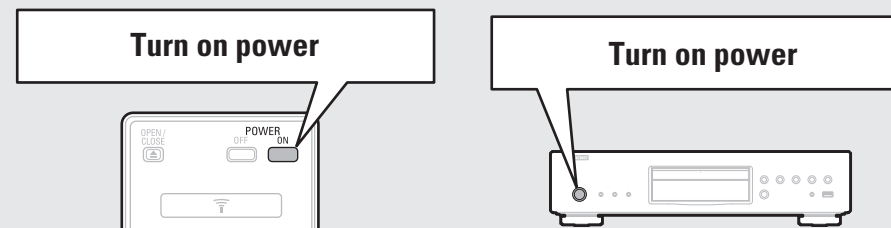

- "LOADING" appears on the display, and disc information is read.
- The "NO DISC" message is displayed if a disc is not loaded.



Before using a remote control, insert the batteries (see page 44 "Inserting the batteries").

## 3 Set up the audio (HD Audio Setup)



An audio format recorded on a Blu-ray Disc is an HD Audio (High Definition Audio) format, such as Dolby TrueHD, Dolby Digital Plus, DTS-HD, etc. For playing back audio of an HD Audio format, the AV receiver to which the unit is to be connected must support HD Audio playback. This section describes the setting for audio output depending on the AV receiver to be connected, outputting the Audio format as-is or converting to normal digital audio.

- 1** Press .  
The disc tray opens.

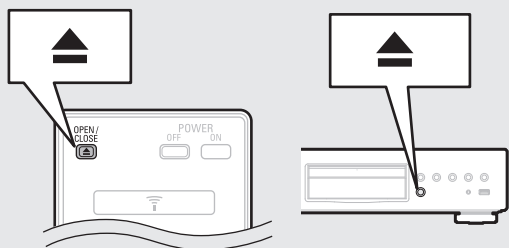

- 2** Place the disc on the disc tray with the label side up.

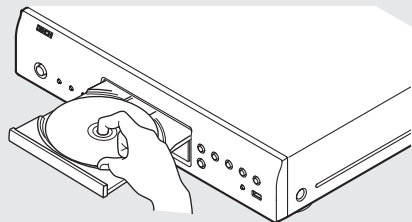

- 3** Press .  
The disc tray closes, and playback of the disc begins.

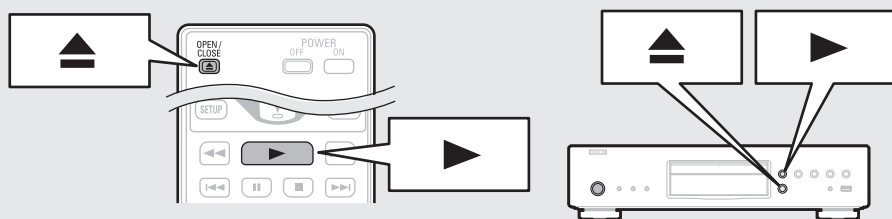

### NOTE

- Do not push the disc tray in by hand. It may damage the player.
- Some discs require pressing to start playback. In this case, press to start playback.

- 4** Press **MODE**.  
Displays a menu of items that can be set.

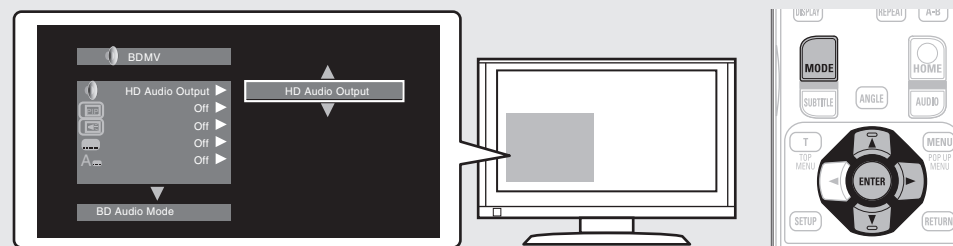

- 5** Use to select “BD Audio Mode”, then press **ENTER** or .

- 6** Use to select “HD Audio Output” or “Mix Audio Output”, then press **ENTER**.

### For listening to a BD disc with high quality

Set “BD Audio Mode” to “HD Audio Output”.

- HD audio of a BD disc is output from the unit.



- Only main audio of HD audio is output.
- Before connecting the unit to an AV receiver, check that the receiver supports HD audio playback. If it does not, the unit outputs the signal converted to LPCM from the HDMI output terminal. HD audio is not output.

### For listening to subaudio of a BD disc (interactive audio or secondary audio)

Set “BD Audio Mode” to “Mix Audio Output”.

- When the unit plays a BD, HD Audio of the BD is converted to normal digital audio and output.



Specifications of interactive audio or secondary audio differ depending on the Blu-ray Disc. For details, refer to the package or operation manual supplied with the Blu-ray Disc.



Setting the audio during playback.

# 4 Play back disc

**1** Press **TOP MENU** or **MENU**.  
The menu stored on the disc is displayed.

**2** Select the playback title or chapter from the top menu for playback.

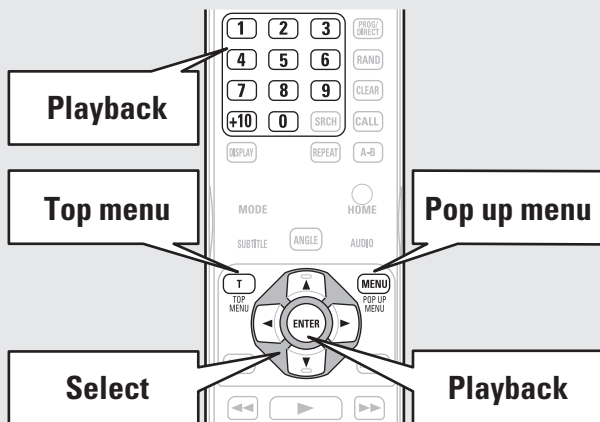

[Example]

□ Disc menu



□ Top menu

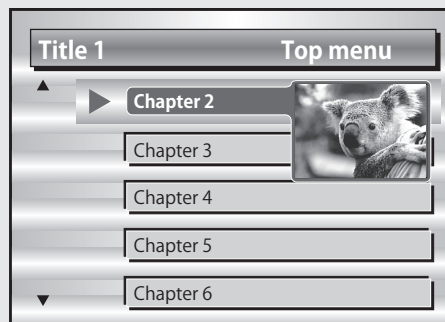

□ Pop up menu

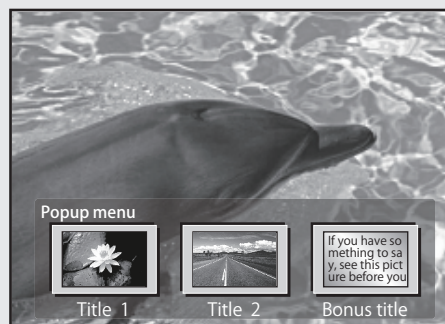

## When power is switched to standby

Press either **POWER OFF** on the remote control, or **ON/STANDBY** on the unit.

- The power indicator flashes in green. Then the indicator lights in red and the power is turned off.

### [Power indicator status in standby mode]

- Power Saving Standby : Off
- Normal Standby : Red

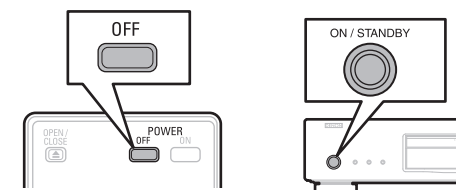

When "Auto Power Mode" is "On" (page 34), the following states are maintained for about 30 minutes, and then the power is automatically turned to standby.



- Disc not loaded
- Playback has stopped
- Stopped due to resume function

### NOTE









During power standby, a slight amount of power is consumed. To totally cut off the power, remove the power cord from the power outlet.

## Basic version

This section describes the operations for enjoying video and audio on a disc.

- **Basic connections**  **page 9**
- **Playback (Basic operation)**  **page 13**
- **Basic settings**  **page 21**

Refer to the pages indicated below for information on connecting and playing back the various media and external devices.

Audio and video	Connection	Playback
BD / DVD-Video	 page 9 – 12	 page 14
DVD-Audio	 page 9 – 12	 page 16
Audio	Connection	Playback
Super Audio CD	 page 9 – 12	 page 15
CD	 page 9 – 12	 page 16

# Basic connections

## Important information

- Connect this unit as follows before using. Make connections according to the equipment you are connecting.
- Some settings of this unit may be necessary depending on the connection method. Check each connection item for more information.
- Select the cables (sold separately) according to the components being connected.

### NOTE

- Do not plug in the power cord until all connections have been completed.
- When making connections, also refer to the operating instructions of the other components being connected.
- Be sure to connect the left and right channels properly (left with left, right with right).
- Do not bundle power cords together with connection cables. Doing so can result in noise.

## Connecting an AV receiver

For connecting using an HDMI cable, see "Connect" (page 4). This section describes the connections not using an HDMI cable.

### Connecting to an AV receiver with an analog 2-channel audio input terminal

- This connection is recommended when the specifications of an AV receiver connected to the unit are as follows:
  - Not supporting HDMI input
  - Not supporting digital audio(coaxial) input
- Select the connector to use and connect the device.

### Cables used for connections



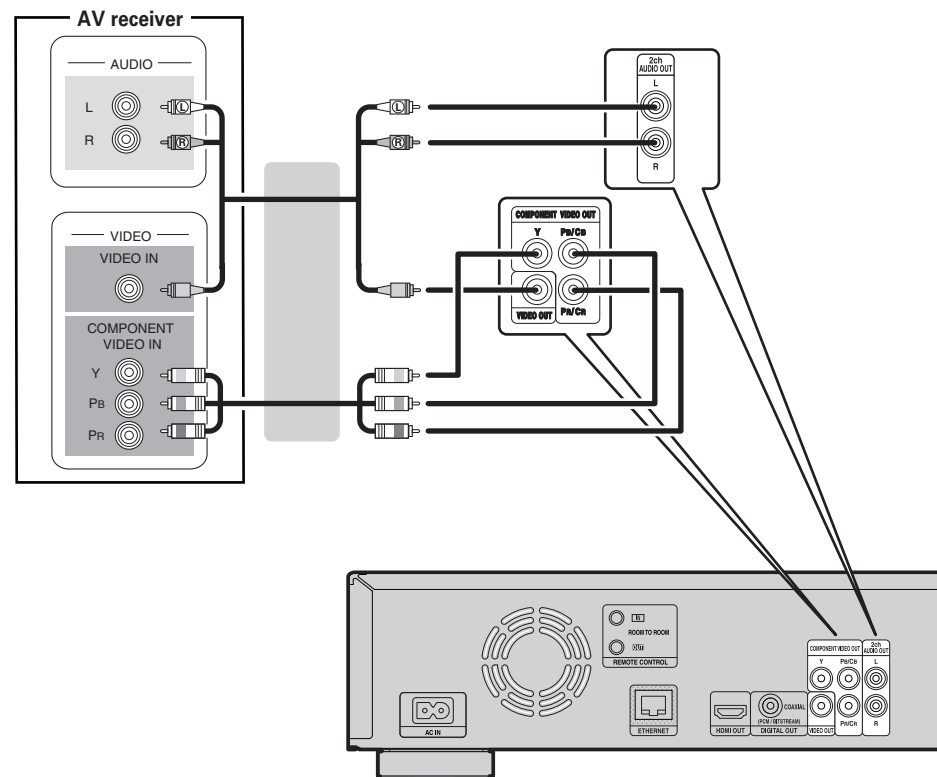



Audio and video cable	
Audio and video cable (supplied)	(White) (Red) (Yellow)
Video cable	
Component video cable (sold separately)	(Green) (Blue) (Red)



## Connecting to an AV receiver with a digital audio input terminal

- This connection is recommended when the specifications of an AV receiver connected to the unit are as follows:
  - Not supporting HDMI input
  - Supporting digital audio(coaxial) input
- This connection enables faithfully playing a disc that supports 5.1-channel output.
- Select the connector to use and connect the device.

### Cables used for connections

Audio cable	
Coaxial digital cable (sold separately)	(Black) 
Audio and video cable	
Audio and video cable (supplied)	(White)  (Red)  (Yellow) 
Video cables	
Component video cable (sold separately)	(Green)  (Blue)  (Red) 

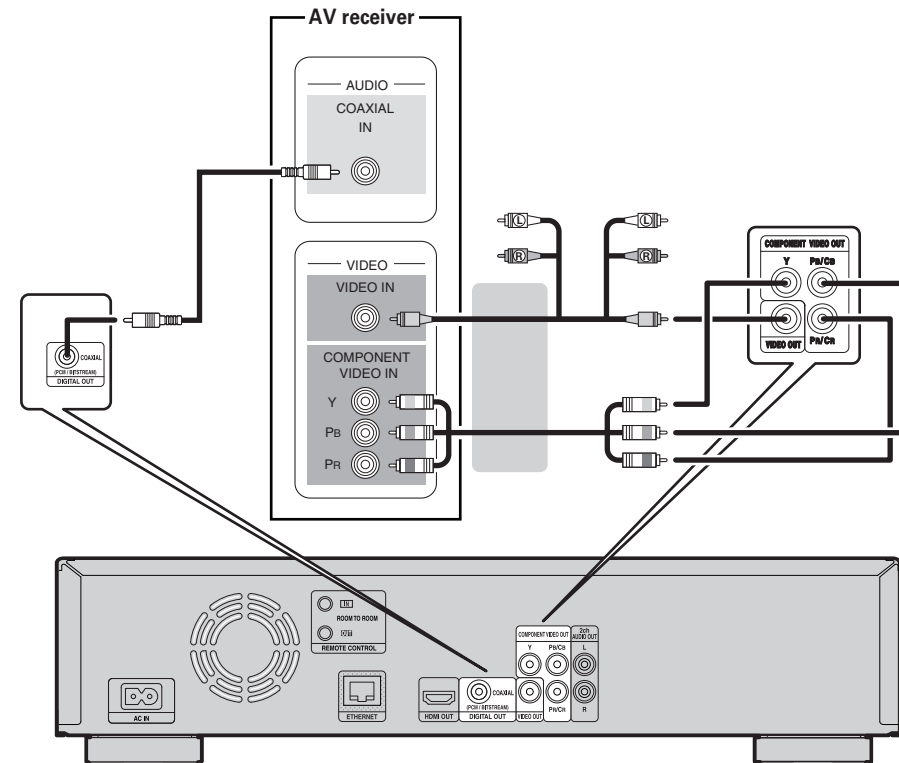

When playing back Dolby Digital Plus/Dolby TrueHD/DTS-HD audio recorded on a BD disc, this unit outputs Dolby Digital or DTS bitstream from its digital audio output terminal.

### NOTE

- Dolby TrueHD/Dolby Digital Plus/DTS-HD audio signals are not output with this connection. When outputting Dolby TrueHD/Dolby Digital Plus/DTS-HD audio signals, do so with an HDMI connection (page 4).
- Super Audio CD's DSD signal cannot be output. Also, during CD layer playback, 44.1 kHz/16-bit Linear PCM is output.
- Do not output DTS audio signals to an AV receiver that does not support DTS. Playing back a BD/DVD disc with recorded DTS content can generate noise and even damage your speakers.

# Connecting a TV

- This connection is to connect the unit and a television directly.
- Check the television's audio and video terminals and connect to one of them.

## Cables used for connections

Audio and video cable	
HDMI cable (sold separately)	
Audio and video cable (supplied)	(White)
	(Red)
	(Yellow)
Video cables	
Component video cable (sold separately)	(Green)
	(Blue)
	(Red)

### NOTE

- Do not connect this unit's video output via a VCR (Video Cassette Recorder). Some media contain copy prohibiting signals, which will disturb the screen image.
- The unit can play both NTSC and PAL discs.

### When connected to the television's component video input terminal

Press **RESOLUTION** according to the resolution of the connected television (page 22).

- This unit's component video output supports 480i/576i/480p/576p/720p/1080i output .
- Images will not be projected normally if the television resolution and this unit's output resolution do not match.
- Copyright protected DVD is output in 480i/576i or 480p/576p.

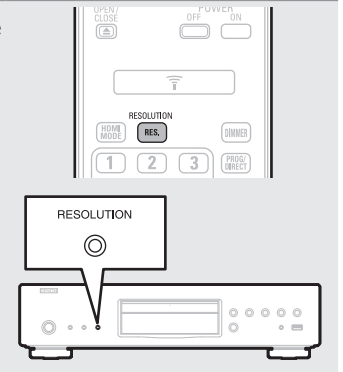

### Connecting to a device equipped with a DVI-D connector

Use an HDMI DVI-D conversion cable.

- The audio signal is not output. Make the appropriate audio connections for your devices.
- The video signal will be in RGB format.
- You cannot output to a DVI-D device that does not support HDCP (high-bandwidth digital content copyright protection system).
- Video may not be output depending on the combination of devices.

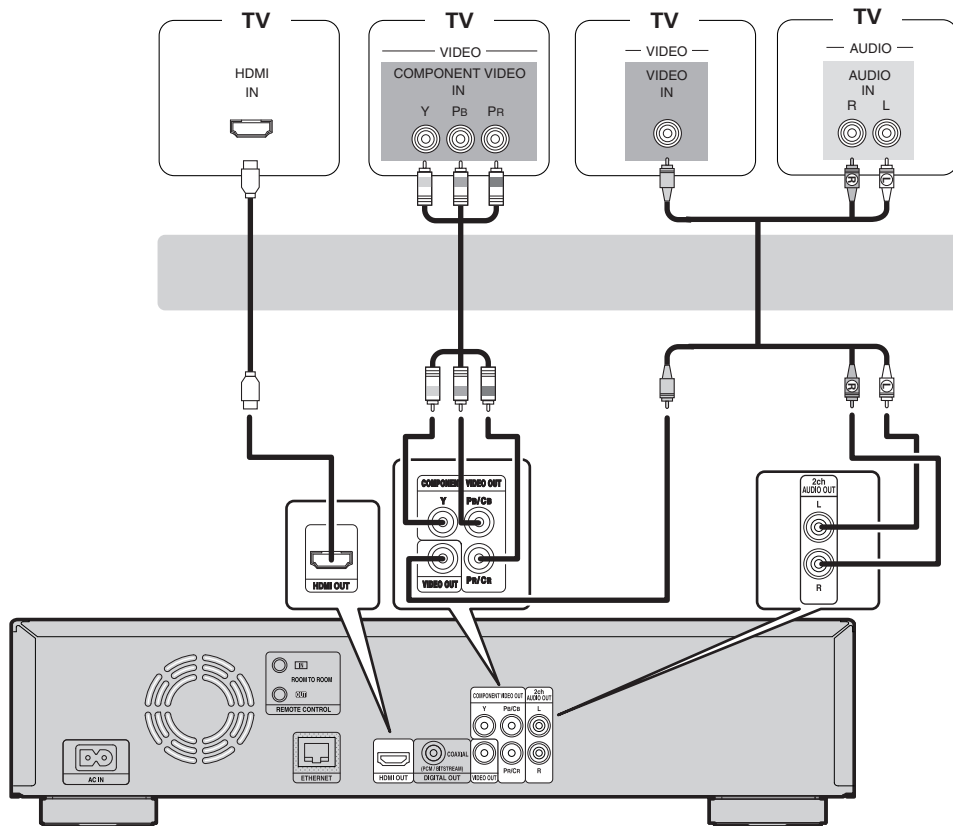

Simple version

Basic version

Advanced version

Information

## Connecting a 2-channel audio amplifier

This connection is for playback of audio of this unit, using a 2-channel audio device.



For software recorded in multi-channel, an analog signal down-mixed to 2-channel is output.

### Cables used for connections

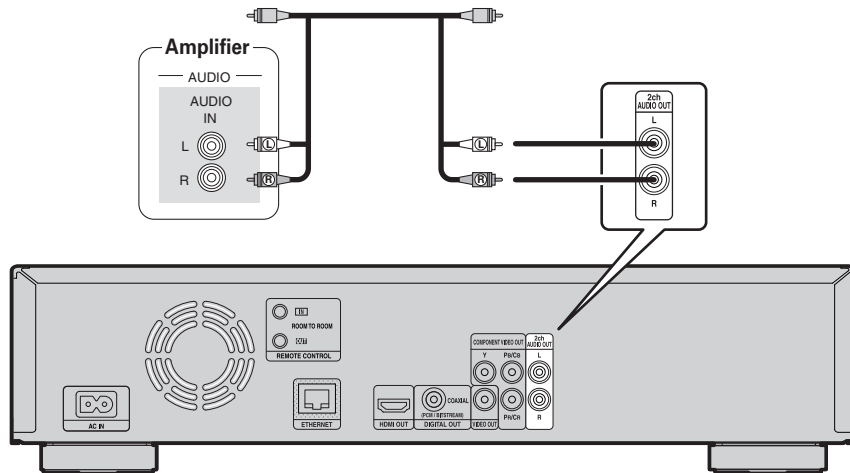
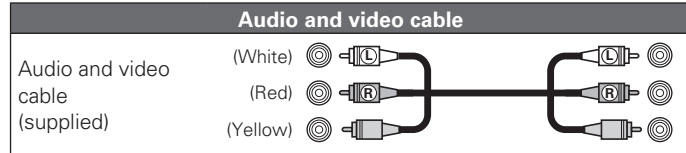

## Connecting to a digital recording device

This connection is for recording audio from this unit, using an audio device with coaxial digital audio input terminals.

### Cables used for connections

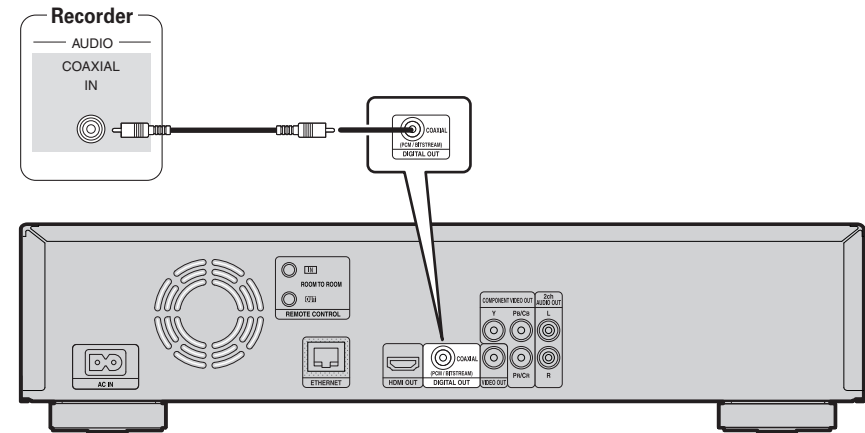
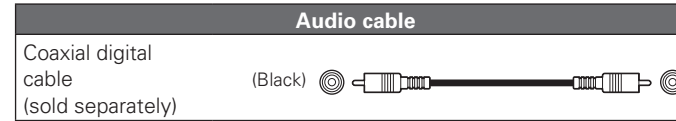

When multi-channel audio is to be converted to 2-channel audio and output, change the setting for a connected Coaxial digital output to PCM from Bitstream, then make the setting for the sampling rate for digital audio output, depending on the device (see page 39 "Down Sampling").

### NOTE



If you play back BD/DVD or other media with an incorrect configuration, a deafening noise occurs that may damage your speakers.



# Playback (Basic operation)

This section describes the display screen for each media and the procedures for playback.

The icons show the category of content applicable to each operation.

	<b>Video : Blu-ray Disc, DVD-Video, DivX plus HD, MPEG, AVI, WMV, AVCHD</b>
	<b>Audio : Super Audio CD, CD, DVD-Audio, MP3, WMA, AAC, LPCM</b>
	<b>Photo : JPEG</b>

- ❑ **About playback information** (👉 page 13)
- ❑ **Playing BD and DVD-Video** (👉 page 14)
- ❑ **Playing Super Audio CD** (👉 page 15)
- ❑ **Playing CD** (👉 page 16)
- ❑ **Playing DVD-Audio** (👉 page 16)

**Operations enabled during playback** (👉 page 17)

**Basic settings** (👉 page 21)

**NOTE**

- The symbol  (prohibited mark) may appear on the top left of the TV screen during an operation. This means that the operation being conducted is prohibited.
- Depending on the disc, certain operations may not be as described in this manual. Check each disc owner's manual for more information.
- During playback of a 2-layered disc, pictures may stop momentarily. This happens when the 1st layer switches to the 2nd layer. This is not a malfunction.

## About playback information

Press **DISPLAY** to display the information bar display or media player display.

- To close the display, press **DISPLAY** until it goes away.
- Displayed content differs depending on the media being played. Also, the information displayed while playing and stopped differs.



### Information bar display



This screen is displayed when video data such as on a Blu-ray Disc, DVD-Video, etc. are played.

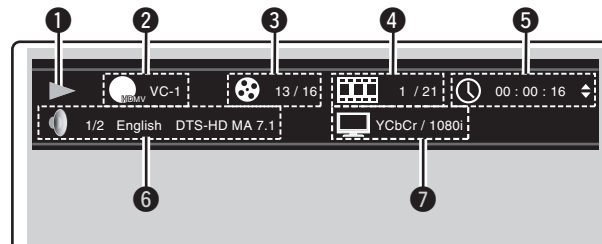

- 1 Playback information**
  - Play (▶)
  - Stop (■)
  - Pause (||)
  - Reverse Skip (◀◀) / Forward Skip (▶▶)
  - Fast Reverse (◀◀) / Fast Forward (▶▶)
  - Slow Reverse (◀) / Slow Forward (▶)
- 2 Video format display**
- 3 Title / Group display**
- 4 Chapter / Track display**
- 5 Time display**
  - Title Elapsed / Remain time
  - Chapter Elapsed / Remain time
  - Group Elapsed / Remain time
  - Track Elapsed / Remain time
- 6 Audio format display**
- 7 HDMI output signal display**  
(When the connected HDMI device)

### Media player display



This screen is displayed when audio data is played.

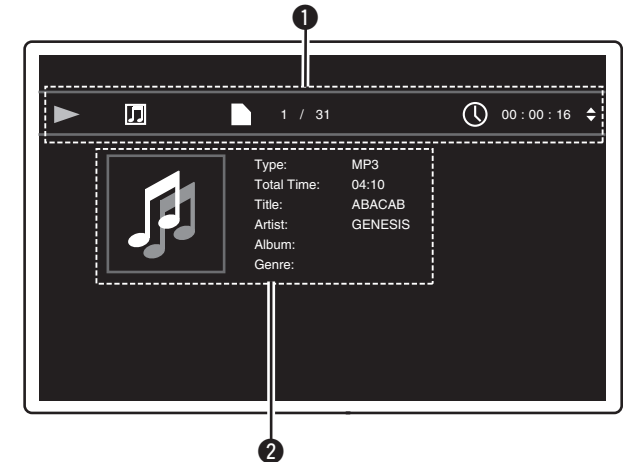

- 1 Playback information**
  - Play (▶)
  - Stop (■)
  - Pause (||)
  - Reverse Skip (◀◀) / Forward Skip (▶▶)
  - Fast Reverse (◀◀) / Fast Forward (▶▶)
  - Slow Reverse (◀) / Slow Forward (▶)
- 2 Media information**
  - Type
  - Total Time
  - Title
  - Artist
  - Album
  - Genre
  - Artwork

The icons show the category of content applicable to each operation.



Video



Audio



Photo

For details of the media corresponding to each icon, see "Playable media" (👉 page 45).



## Playing BD and DVD-Video

**1** Press **POWER ON** to turn on power to the unit.

**2** Press **SOURCE** on the unit to select "DISC MODE".

**3** Select "BD" with **DISC LAYER**.

• The Media changes each time **DISC LAYER** is pressed for 2 seconds.

Multi → Audio → BD

**Multi** Super Audio CD

**Audio** DVD-Audio

**BD** Hybrid BD

**4** Select "BD layer" or "DVD layer" for **DISC LAYER** for playback of a hybrid BD disc (☞ page 47).

**BD** Plays the BD layer of the BD hybrid disc.

**DVD** Plays the DVD layer of the BD hybrid disc.

• The above setting is necessary only for BD hybrid discs.

### NOTE

Select the disc layer before a disc is inserted.

**5** Insert a disc.  
Press **▲** to open/close the disc tray.

**6** Press **▶**.  
Playback begins.

**7** During DVD-Video playback, press **TOP MENU** or **POP UP MENU** to display the menu.



- If the menu continues, press **△▽◀▶** to get to the next part.
- With BD, depending on the disc, you can select title and chapter from the pop up menu.

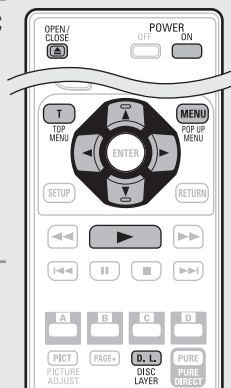
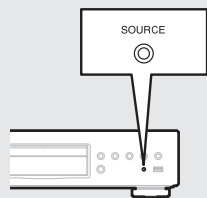

**8** Make the settings shown below on the disc menu.

- Subtitle language
- Audio language
- Audio format etc.

[Example]

Disc menu



Top menu

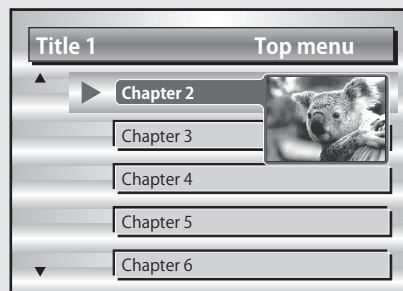

Pop up menu

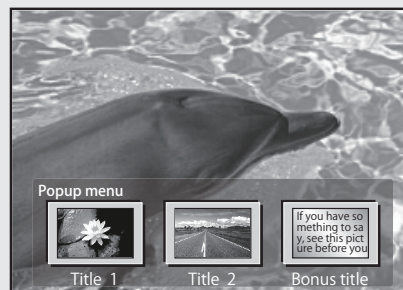

- Pausing (☞ page 17)
- Stopping (☞ page 17)
- Skipping to a desired chapter/track/file (☞ page 17)
- Fast-forward/fast-reverse (☞ page 17)
- Finding specific sections with search modes (☞ page 18)
- Memorizing locations to replay (Marker function) (☞ page 18)
- Playing repeatedly (Repeat playback) (☞ page 19)
- Playing repeatedly between specified points (A-B repeat) (☞ page 19)
- Playing images frame by frame (☞ page 19)
- Slow-forward/slow-reverse (☞ page 19)
- Switching primary audio (☞ page 19)
- Changing the primary subtitle (☞ page 20)
- Switching the angle (☞ page 20)

## Playing BD-Video compatible with Bonus View



With a disc that is compatible with bonus view (picture-in-picture), in addition to the main video (primary video) stored on the disc, you can play back the video director's commentary and simultaneously ongoing sub-story, as well as sub-video such as alternative camera angles (secondary video).

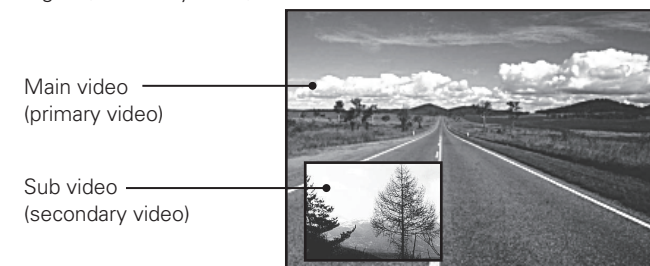

[Example] Bonus view



**1** Press **MODE** (☞ page 24).

**2** Use  $\Delta$ / $\nabla$  to select “Secondary Video”, and then press **ENTER** or  $\triangleright$ .

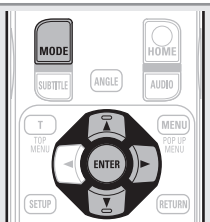

**3** Use  $\Delta$ / $\nabla$  to select the desired secondary video.

Off  $\longleftrightarrow$  1/X  $\longleftrightarrow$  2/X  $\longleftrightarrow$  X/X

<b>Off</b>	Does not display Secondary Video.
<b>1/X</b>	Displays the first Secondary Video.
<b>2/X</b>	Displays the second Secondary Video.
<b>X/X</b>	Displays the X th Secondary Video.

- “X” is the number of Secondary Videos recorded and differs depending on the disc.



- For using Bonus View, some BD discs require built-in memory or external memory.
- The unit has a built-in memory. If the memory capacity used for Bonus View will exceed the remaining built-in memory capacity, using a USB memory device of 1 GB or more is recommended.
- The playback method, etc., is determined by the disc, and varies depending on the disc. Refer to the operation guide of the relevant disc.

## Enjoying BD-LIVE™



If the unit is connected to the Internet environment, you can enjoy a BD-LIVE™ function, using a disc that supports BD-LIVE™. For details on functions and operations of BD-LIVE™, see the information displayed on the screen after inserting a BD-LIVE™ disc.

**1** Select “Internal” of “BD Data Utility” – “BD-Live Memory” (☞ page 34).

**2** Check that the connection and settings for the Internet are completed (☞ page 36 “Connection Test”).

**3** Insert a Blu-ray Disc that supports BD-LIVE™ into the unit.

**4** Select “BD-LIVE™” from the Disc menu.



- When BD-LIVE™ is used, the downloaded contents are stored in the built-in memory of the unit.
- The unit has a built-in memory. If the memory capacity used for BD-LIVE™ will exceed the remaining built-in memory capacity, using a USB memory device of 1 GB or more is recommended.
- Depending on your network environment, it may take time to connect to the network or connection may not be possible.

### NOTE USB memory devices (☞ page 26, 45)

- For using a USB memory device, set “BD Data Utility” – “BD-Live Memory” to “External” (☞ page 34).
- The USB memory device must have been initialized (☞ page 34 “BD Data Utility” – “BD Data Information”).
- Insert or remove a USB memory device while the power is in standby. If you insert a USB memory device while the power is ON, the USB memory device may not be access.

## Playing Super Audio CD



**1** Press **POWER ON** to turn on power to the unit.

**2** Press **SOURCE** on the unit to select “DISC MODE”.

**3** Select “Multi” with **DISC LAYER**.

- The Media changes each time **DISC LAYER** is pressed for 2 seconds.

→ Multi → Audio → BD →

<b>Multi</b>	Super Audio CD
<b>Audio</b>	DVD-Audio
<b>BD</b>	Hybrid BD

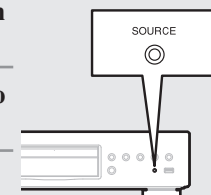

**4** Select the playback area and layer with **DISC LAYER** (☞ page 47).

<b>Multi</b>	Plays the multi-channel area of the HD layer.
<b>Stereo</b>	Plays the 2-channel area of the HD layer.
<b>CD</b>	Plays the CD layer.

### NOTE

Select the disc layer before a disc is inserted.

**5** Insert a disc.  
Press  $\blacktriangle$  to open/close the disc tray.

**6** Press  $\blacktriangleright$ .  
Playback of the selected area and layer begins.



- To play a disc in multichannel mode, connect the unit to an AV receiver, using an HDMI cable.
- The area/layer selected with **DISC LAYER** remains in the memory even when the power is turned off.



Playing Super Audio CD

- ❑ Pausing (👉 page 17)
- ❑ Stopping (👉 page 17)
- ❑ Skipping to a desired chapter/track/file (👉 page 17)
- ❑ Fast-forward/fast-reverse (👉 page 17)
- ❑ Finding specific sections with search modes (👉 page 18)
- ❑ Playing repeatedly (Repeat playback) (👉 page 19)
- ❑ Playing repeatedly between specified points (A-B repeat) (👉 page 19)
- ❑ Switching primary audio (👉 page 19)
- ❑ Playing in random order (Random playback) (👉 page 20)
- ❑ Playing in your preferred order (Program playback) (👉 page 20)

Playing CD

- 1 Press **POWER ON** to turn on power to the unit.
- 2 Press **SOURCE** on the unit to select “DISC MODE”.
- 3 Insert a disc.  
Press **▲** to open/close the disc tray.
- 4 Press **▶**.  
Playback begins.

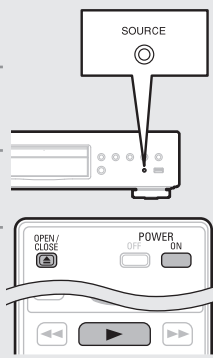

- ❑ Pausing (👉 page 17)
- ❑ Stopping (👉 page 17)
- ❑ Skipping to a desired chapter/track/file (👉 page 17)
- ❑ Fast-forward/fast-reverse (👉 page 17)
- ❑ Finding specific sections with search modes (👉 page 18)
- ❑ Playing repeatedly (Repeat playback) (👉 page 19)
- ❑ Playing repeatedly between specified points (A-B repeat) (👉 page 19)
- ❑ Switching primary audio (👉 page 19)
- ❑ Playing in random order (Random playback) (👉 page 20)
- ❑ Playing in your preferred order (Program playback) (👉 page 20)

Playing DVD-Audio

- 1 Press **POWER ON** to turn on power to the unit.
- 2 Press **SOURCE** on the unit to select “DISC MODE”.
- 3 Select “Audio” with **DISC LAYER**.

• The Media changes each time **DISC LAYER** is pressed for 2 seconds.



Multi	Super Audio CD
Audio	DVD-Audio
BD	Hybrid BD

- 4 Select the playback part with **DISC LAYER** (👉 page 47).

Audio	Plays the audio part.
Video	Plays the video part.

**NOTE**  
Select the disc layer before a disc is inserted.

- 5 Insert a disc.  
Press **▲** to open/close the disc tray.
- 6 Press **▶**.  
Playback of the selected part begins.

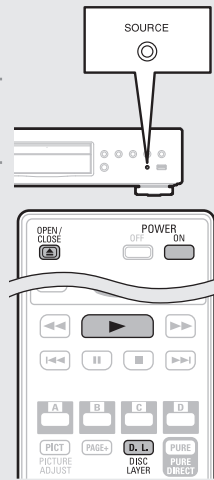

- ❑ **Playing bonus group**  
DVD-Audio discs may have a bonus group that can be played after entering a password.

**If you enter the wrong password**

Select the bonus group again and enter the correct password.



- ❑ **Selecting still images**

When a DVD-Audio disc has still images on it, you can choose the image to display.

**Press PAGE + during playback.**  
The next still image is displayed.

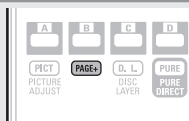



- ❑ Pausing (👉 page 17)
- ❑ Stopping (👉 page 17)
- ❑ Skipping to a desired chapter/track/file (👉 page 17)
- ❑ Fast-forward/fast-reverse (👉 page 17)
- ❑ Finding specific sections with search modes (👉 page 18)
- ❑ Playing repeatedly (Repeat playback) (👉 page 19)
- ❑ Playing repeatedly between specified points (A-B repeat) (👉 page 19)
- ❑ Switching primary audio (👉 page 19)
- ❑ Playing in random order (Random playback) (👉 page 20)
- ❑ Playing in your preferred order (Program playback) (👉 page 20)

















# Operations enabled during playback

This section describes the operations enabled during playback for each media.

The icons show the category of content applicable to each operation.

	<b>Video : Blu-ray Disc, DVD-Video, DivX plus HD, MPEG, AVI, WMV, AVCHD</b>
	<b>Audio : Super Audio CD, CD, DVD-Audio, MP3, WMA, AAC, LPCM</b>
	<b>Photo : JPEG</b>

## Playback (Basic operation) page 13

- Pausing**  page 17
- Stopping**  page 17
- Skipping to a desired chapter/track/file**  page 17
- Fast-forward/fast-reverse**  page 17
- Finding specific sections with search modes**  page 18
- Memorizing locations to replay (Marker function)**  page 18
- Playing repeatedly (Repeat playback)**  page 19
- Playing repeatedly between specified points (A-B repeat)**  page 19
- Playing images frame by frame**  page 19
- Slow-forward/slow-reverse**  page 19
- Switching primary audio**  page 19
- Changing the primary subtitle**  page 20
- Switching the angle**  page 20
- Playing in random order (Random playback)**  page 20
- Playing in your preferred order (Program playback)**  page 20

## Basic settings page 21

## Pausing

Press **II** during playback.

The **II** indicator will light on the display.

- Resume normal playback by pressing **▶**.



## Stopping

Press **■** during playback.

Playback stops.



## About the resume function

When playback is stopped, the stop position is memorized.

- The **▶** indicator flashes on the display. To resume play from the stop position, press **▶** while stopped.

## To cancel the resume function

Perform one of the following operations.

- Press **■** while stopped.
- Open the disc tray.
- Change the playback media mode with **HOME**.



- The resume function does not work with menu playback or BD-J (Blu-ray Disc Java) compatible discs.
- The resume function is cancelled when the power is cut off by unplugging the power cord and when the power is set to standby.
- The resume function does not work depending on the disc.

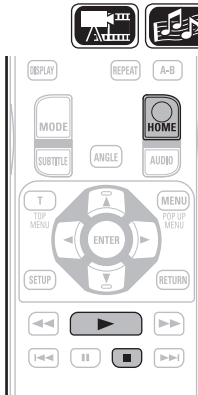

## Skipping to a desired chapter/track/file

During playback, press **◀◀** or **▶▶**.

- ◀◀** Playback begins from the start of the chapter/track/file being played.
- ▶▶** Playback begins from the start of the next chapter/track/file.

- Continue pressing and skip to the chapter/track/file by the number of times pressed.

### NOTE

Skipping to the start of a title or group may be prohibited, depending on the disc.



## Fast-forward/fast-reverse

During playback, press **◀◀** or **▶▶**.

- The fast-forward/fast-reverse speed changes in the sequence of x1, x2, x3, x4, x5, and normal speed each time the button is pressed.
- The speed varies with the disc and file.
- Resume normal playback by pressing **▶**.



- You cannot fast-forward/fast-reverse across files or tracks during program or random playback.
- Fast-forward/fast-reverse may be disabled with some DivX® files.
- Audio is not output during fast-forward/fast-reverse of a BD or DVD.

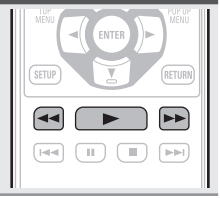

## Finding specific sections with search modes

**1 Press SRCH to select a search.**  
The search mode setting bar is displayed at the top of the screen.



- The search mode changes each time the button is pressed.



**2 Move the blue cursor at the upper part of the screen to the mode to be searched for, using ◀ ▶, then press ENTER.**

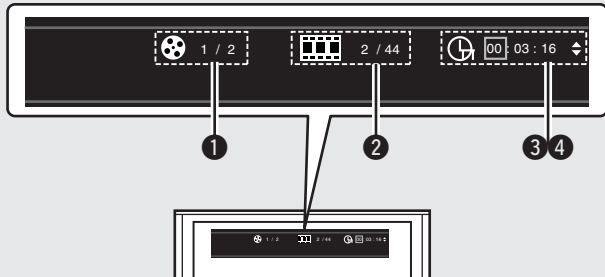

**1 Title/Group/Track search display**

**2 Chapter/Track search display**

- Enter the time, using the number buttons or ◀ ▶, then press **ENTER**.
- The playback of the designated part begins.

**3 Title/Chapter Time search display**

**4 Track/Disc Time search display**

- Select “Title Time search” or “Chapter Time search”, using ◀ ▶, then press **ENTER**.
- Then enter the time using the number buttons or ◀ ▶, then press **ENTER**.
- The playback of the designated part begins.

**3 Enter search conditions or make settings on the search mode setting bar.**

Once an entry is finalized, it searches for the specified location.

**0 - 9, +10**..... Number entry  
**◀ ▶**..... Select  
**ENTER**..... Playback  
**CLEAR**..... Clear



- Entering numbers  
 To enter 3..... **3, ENTER\***  
 To enter 26..... **2, 6, ENTER\*** or **+10, +10, 6**  
 To enter 138..... **1, 3, 8, ENTER\***  
 \* Depending on number of recorded songs or chapters, you may not need to use **ENTER**.
- Time search works with title and chapters playback time.
- When an input is not correct, press **CLEAR**. The previous status is retrieved.

### [Search mode-compatible media and files]

	Contents		
Search mode			
<b>Title/Group/Track search</b>		○	○*
<b>Chapter/Track search</b>		○	○
<b>Title/Chapter Time search</b>		○	○*
<b>Track/Disc Time search</b>		○	○

\* Only DVD-audio can be searched.

### NOTE

- If you search during program/random playback, the program/random playback stops.
  - Search modes may not operate with some discs.
- When the entry mode for title/chapter/title time/chapter time search continues for about 5 seconds with no operation, it is cancelled.
- When the power is set to standby or the disc is removed, the set marker is deleted.

## Memorizing locations to replay (Marker function)



You can attach a marker to a location you want to view or hear again, so that playback begins at that location.

**1 Press SRCH to select a Marker search.**

The Marker search mode setting bar is displayed at the top of the screen.

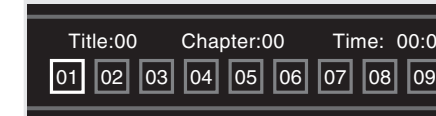

**2 Press ENTER during playback.**

- The location is registered for the selected marker number.
- The marker numbers “01” to “12” are registered in this order.
- The registered number is displayed in white letters.
- The elapsed playing time at the set location is displayed.

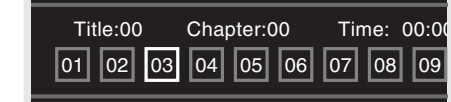

### To play back memorized locations

Use ◀ ▶ to select the marker number, then press **ENTER**.

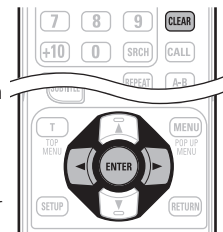

### To erase markers

Each time **CLEAR** is pressed, the marker number is erased from up to date registered.



- Subtitles may not appear depending on the locations you have memorized.
- The markers you have set will be erased if you turn the power to standby or eject the disc.
- The marker function does not operate across titles and groups.
- Marker search can only be performed during playback.
- The marker function does not work depending on the disc.



## Playing repeatedly (Repeat playback)



### Press REPEAT during playback.

The repeat mode icon is displayed at the top of the screen.

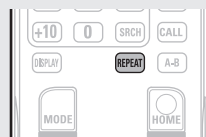

- The repeat mode changes each time the button is pressed.

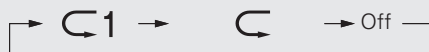

- To resume normal playback, press **REPEAT**, and select "Repeat Off".

### [About repeat modes]

The available repeat modes vary depending on the disc or file you are playing.

Contents				Display
Mode				
Title repeat	<input type="checkbox"/>	<input type="checkbox"/>	<input type="checkbox"/>	
All repeat	<input type="checkbox"/>	<input type="checkbox"/>	<input type="checkbox"/>	
Chapter repeat	<input type="checkbox"/>	<input type="checkbox"/>	<input type="checkbox"/>	
Track repeat	<input type="checkbox"/>	<input type="checkbox"/>	<input type="checkbox"/>	



- Some repeat modes may not be accessible depending on some discs.
- With some discs, even when set to repeat playback, the disc may not return to the start of title or chapter, and may advance to the next scene.
- Repeat playback is not available during A-B repeat playback.

## Playing repeatedly between specified points (A-B repeat)



### 1 During playback, press A – B at the desired starting point (A).

The "A-" indicator will light on the display.

- To cancel the starting point (A), press **CLEAR**.



### 2 Press A – B again at the desired ending point (B).

The "B" indicator will light on the display, and A-B repeat playback will start.

- The A-B repeat mode icon is displayed on the top of the screen.
- To resume normal playback, press **A – B**, and select "Repeat Off".

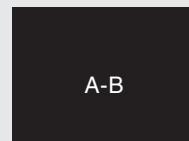

- You cannot skip a title/file with A-B repeat.
- If you perform a search operation during A-B repeat playback, A-B repeat playback is cancelled.
- A-B repeat playback may not be available with some scenes.
- A-B repeat playback may not be available with some DivX® files.
- A-B repeat playback is not available with BD-J (Blu-ray Disc Java) compatible discs.

## Playing images frame by frame



### Press II while paused.

The disc advances frame by frame each time the button is pressed.

- Resume normal playback by pressing **▶**.



Frame by frame reverse playback is not available with the unit.

## Slow-forward/slow-reverse



### Press ◀◀ or ▶▶ while paused.

The speed changes in the sequence of 1/16, 1/8, 1/4, 1/2, and normal speed each time the button is pressed.

- Resume normal playback by pressing **▶**.

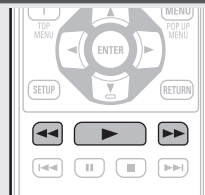

Audio is not output during slow-forward/slow-reverse playback.

## Switching primary audio



With discs and files that have multiple audio track recording, you can change the audio during playback.

### Press AUDIO during playback.

- The audio number currently being played is displayed.
- Each time **AUDIO** is pressed, the audio supported by a disc is changed.

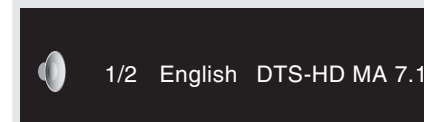

- If multiple audio items are recorded, the current audio number/number of recorded audio items is displayed.



- Depending on the disc, audio switching may be restricted to operation of the disc menu. In this case, switch the audio on the disc menu.
- With a DivX® file, "MP3" or "Dolby Digital" audio formats and the number of recorded audio modes are displayed. "---" appears for audio other than these.
- With DTS-CD (5.1 music disc), you cannot switch audio modes.



## Changing the primary subtitle



During playback of a disc or file with recorded subtitles, you can switch the subtitles on/off as well as the subtitle language.

### Press **SUBTITLE** during playback.

- The subtitle number currently being played is displayed.
- Each time **SUBTITLE** is pressed, the subtitle language supported by a disc is changed.



- If a disc does not include subtitles, "Prohibited mark" is displayed.
- Depending on the disc, subtitle switching may be restricted to operation of the disc menu. In this case, switch the subtitles on the disc menu.
- With a DivX® file, the currently playing subtitle number and number of recorded subtitles are displayed; the language option is not displayed.

## Switching the angle



During playback of a BD or DVD-Video recorded with several camera angles, you can change the angle.

### Press **ANGLE** during playback.

- The angle number for current playback is displayed.
- Each time **ANGLE** is pressed, the angle supported by a disc is changed.



### NOTE

Angle changing may be restricted, depending on the disc.

## Playing in random order (Random playback)



### Press **RAND** during playback.

The "RAND" lights on the display and "Random Mode" is displayed on the screen.



### Resuming normal playback

Press **RAND** during random playback.



Random playback may not be available with some discs.

## Playing in your preferred order (Program playback)



You can program up to a maximum of 15 tracks.

### 1 Press **PROG/DIRECT** during playback.

The "PROG" indicator lights on the display, and the program setting screen appears.

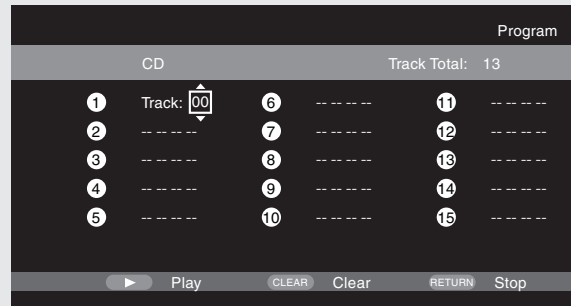

Program playback is not available for music files or DVD-audio.

### 2 Enter the track numbers you want to program on the program setting screen.

0 - 9, +10 ..... Number entry  
 Δ ▽ ..... Select  
**ENTER** ..... Set entry  
**CLEAR** ..... Clear

### 3 Press **▶**.

Playback begins in the programmed order.

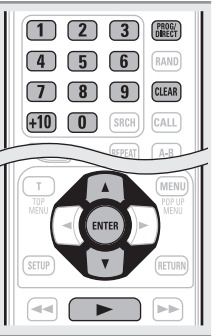

### Checking the program contents

Press **CALL** while stopped.

- The programmed tracks are shown on the display of the unit each time the button is pressed.



- You can also check the contents of the program on the unit's display.
- Repeat playback is available during program playback.



### Resuming normal playback

Press **PROG/DIRECT** during program playback.

- The program setting screen appears and press **PROG/DIRECT**.

### Erasing programmed tracks one by one

Press **CLEAR** on the program setting screen.

- If the unit is set to standby or the disc tray is opened, the program is cleared.







# Basic settings

This section describes the setting operations for basic settings available with the remote control.

The icons show the category of content applicable to each operation.

	<b>Video : Blu-ray Disc, DVD-Video, DivX plus HD, MPEG, AVI, WMV, AVCHD</b>
	<b>Audio : Super Audio CD, CD, DVD-Audio, MP3, WMA, AAC, LPCM</b>
	<b>Photo : JPEG</b>

Basic connections (👉 page 9)

Playback (Basic operation) (👉 page 13)

- Changing the brightness of the display (Dimmer control) (👉 page 21)
- Playing high-quality audio (Pure direct function) (👉 page 21)
- HDMI control functions (👉 page 21)
- Video resolution (👉 page 22)
- Adjusting the picture quality (Picture control) (👉 page 23)
- Mode setting (👉 page 24)

## Changing the brightness of the display (Dimmer control)



The brightness of the display can be changed.

Press **DIMMER**.

- The brightness changes each time the button is pressed.

➔ Normal ➔ Dim ➔ Dark ➔ Off



## Playing high-quality audio (Pure direct function)



This enables you to play high quality audio by stopping the video signal, etc., output, and outputting the analog audio signal only.

Press **PURE DIRECT** while stopped.

- The Pure Direct mode changes each time the button is pressed.

➔ Pure Direct1 ➔ Pure Direct2 ➔ Off

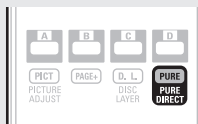

<b>Pure Direct 1</b>	This turns off the digital audio output, video output, and display.
<b>Pure Direct 2</b>	This turns off the digital audio output and video output.
<b>Off</b>	This turns off the pure direct function.



- You cannot use **PURE DIRECT** while the GUI menu is displayed.
- The pure direct setting returns to "Off" when the unit is put in standby mode.

## HDMI control functions

When you make HDMI connections with a TV or AV receiver compatible with this unit and HDMI control functions, you can perform the following operations by setting up the HDMI control functions of each device.

- TV or AV receiver power is turned on by operating the unit and functions change with this unit input.**
- Turning off the TV's power turns the unit's power to standby.**
- Operating the unit via the TV's remote control.** (When the TV's remote control has player operation buttons)

- Set the HDMI control function to "On".**  
GUI menu "System" – "HDMI Control" (👉 page 34).
- Turn on all the equipment connected by HDMI cable.**
- Set the HDMI control function for all equipment connected by HDMI cable.**
  - Please refer to the owner's manuals of connected devices for how to make settings.
  - Carry out steps 2 and 3 if any of the equipment was unplugged.
- To ensure that the unit's HDMI video output is projected on the TV screen, change the input function of the TV and AV receiver.**
- When you turn the TV's power to standby, check that the power of the unit and AV receiver also goes on standby.**



If the HDMI control function does not operate properly, check the following points.

- Is the TV or AV receiver compatible with the HDMI control function?
- Are the HDMI control function settings of all equipment correct? (Step 3)
- After setting, did you add another HDMI device connection or make any changes in the connections? If so make the settings again.

### NOTE

- Some functions may not operate depending on the connected TV or AV receiver. Check the owner's manual of each device for details beforehand.
- When "HDMI Power Off Control" (👉 page 34) is set to "Off", the unit does not go to standby even if the connected device is in the standby mode.

The icons show the category of content applicable to each operation.



Video



Audio



Photo

For details of the media corresponding to each icon, see "Playable media" (👉 page 45).

## Video resolution

This section is for making the settings for television resolution. Set them depending on the connected television.

### Press **RESOLUTION**.

- The resolution is changed as shown below each time **RESOLUTION** is pressed.

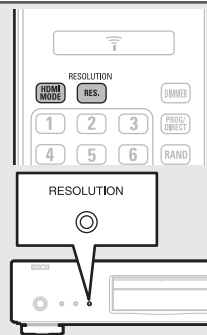

- The default settings is underlined.

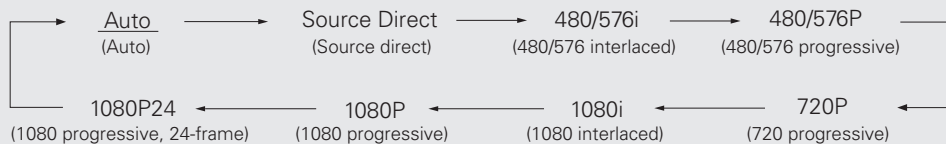

- This unit's component video output supports 480i/576i/480p/576p/720p/1080i output.
- If the Video resolution is not set to "Auto", set it to correspond with the resolution of your television.
- Images will not be projected normally if the television resolution and this unit's output resolution do not match.
- Audio and video will be temporarily interrupted if the power of the connected device currently playing is turned off, or the input is switched.
- When you change the HDMI video resolution of the unit, it takes a few seconds up to about 10 seconds for validation between the unit and the connected device. Audio/video is not output during this period.

### NOTE

When you make the following settings, this unit will output video signals from an HDMI OUT connector with a resolution of 1080P24 (1080 progressive, 24-frame).

- RESOLUTION setting: Set to "Auto", "Source Direct", or "1080P24".
- HDMI mode setting: Set to "24P ON".
- Television resolution supports 1080P24 (1080 progressive, 24-frame).

Under these setting conditions, no video signals are output from VIDEO OUT and COMPONENT VIDEO OUT connectors. To output video signals, press **HDMI MODE** and set HDMI output to "24P OFF".

## HDMI output settings

Most movies on Blu-ray disc are recorded at 24 frames per second, the same as movie film. If the unit is set like this, images with the same quality as movies can be enjoyed.

The setting for outputting signals with 24 video frames in HDMI mode is made here. Then images with fluid motion can be enjoyed when video of 1080P24 (1080 progressive, 24-frame) is played.

### NOTE

You can not use HDMI mode while the GUI menu is displayed.

### Press **HDMI MODE**.

- The current status of HDMI output is displayed on the display.
- Each time **HDMI MODE** is pressed, "24P ON" and "24P OFF" are toggled.
- The default setting is "24P OFF".



### 24P ON

- If the connected television supports "1080P24", use this setting.
- After making settings, set Video Resolution to "1080P24" or "SourceDirect".

### 24P OFF

- If the connected television does not support "1080P24", use this position.

## Adjusting the picture quality (Picture control)

You can adjust the picture quality to your liking.

The adjusted values can be stored in Memory 1 through Memory 5.

- 1 Press PICTURE ADJUST.**  
The currently set status is displayed.

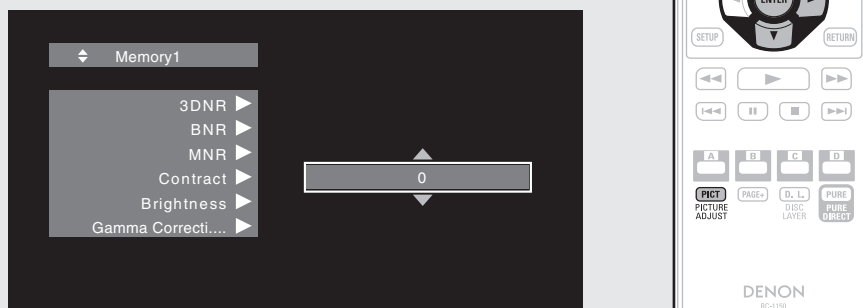

- 2 Press  $\Delta$ / $\nabla$  to select a memory number to be used, and then press ENTER.**

- 3 Press  $\Delta$ / $\nabla$  to select an item then press ENTER or  $\triangleright$ .**

- 4 Change the setting with  $\Delta$ / $\nabla$ .**  
• Refer to the table on the right for information on the different settings.

### To finalize picture adjustments

Press **PICTURE ADJUST** after adjusting.

- The pop up menu of the picture adjustments is disappeared on the screen.



The picture adjustment settings are retained in memory even after the power is turned off.

Setting items	Setting contents	Default
<b>3DNR</b> Reduces noise in the entire picture.	<b>0 – +3</b>	<b>0</b>
<b>BNR</b> Reduces the block noise generated by digital processing.	<b>0 – +3</b>	<b>0</b>
<b>MNR</b> Reduces the noise around the outline of an object generated by digital processing.	<b>0 – +3</b>	<b>0</b>
<b>Contrast</b> Adjusts picture contrast.	<b>-6 – +6</b>	<b>0</b>
<b>Brightness</b> Adjusts picture brightness.	<b>0 – +12</b>	<b>0</b>
<b>Gamma Correction</b> Changes the amount of gamma correction to adjust overall brightness of a picture. Make Dark(-) / bright(+) section easier to see.	<b>-4 – +4</b>	<b>0</b>
<b>Sharpness</b> Adjusts picture sharpness for the higher frequency range.	<b>-6 – +6</b>	<b>0</b>
<b>Hue (color tone)</b> Adjusts the green and red color balance.	<b>-6 – +6</b>	<b>0</b>
<b>Chroma Level</b> Adjusts the color density.	<b>-6 – +6</b>	<b>0</b>
<b>Setup Level*</b> Adjusts the black areas of the image.	<b>0 IRE</b> <b>7.5 IRE</b>	<b>7.5 IRE</b>

\*Effective only for the 480i video signal from the video output terminal.

## Mode setting

You can make various mode settings during playback. The setting menu is displayed at the top of the screen.

- 1 Press MODE.**  
Displays a menu of items that can be set.

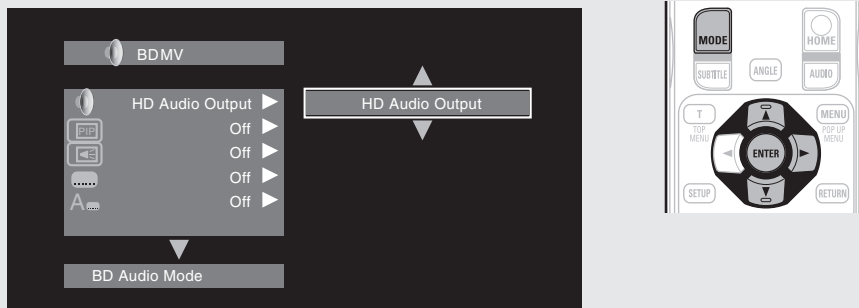

- 2 Select a setting item using  $\Delta$ / $\nabla$ , and then press ENTER or  $\blacktriangleright$ .**



- 3 Use  $\Delta$ / $\nabla$  to select a setting, and then press ENTER.**

- 4 Press MODE.**  
The setting screen is disappeared.







Setting items	Setting details
<b>BD Audio Mode</b> Switch Blu-ray Disc audio playback mode.	<b>HD Audio Output</b> : Can view by outputting high quality signals such as Dolby TrueHD, Dolby Digital Plus, or DTS-HD as its high sound quality bitstream. Cannot listen to interactive or secondary audio. <b>Mix Audio Output</b> : Outputs a mix of primary audio/interactive audio/secondary audio. <b>NOTE</b> When "BD Audio Mode" is set to "Mix Audio Output", DTS-HD MA 192 kHz 5.1ch audio is decoded to 96 kHz 5.1ch.
<b>Secondary Video</b>	<b>Off</b> : Does not display secondary video(Picture-In-picture). <b>1/X*</b> : Displays the first secondary video. <b>2/X*</b> : Displays the second secondary video. <b>X/X*</b> : Displays the X th secondary video. * "X" is the number of secondary video recorded and differs depending on the disc (page 14 "Playing BD-Video compatible with Bonus View").
<b>Secondary Audio</b>	<b>Off</b> : Does not select the secondary audio. The interactive audio is also set to off. <b>1/X*</b> : Selects the first secondary audio. <b>2/X*</b> : Selects the second secondary audio. <b>X/X*</b> : Selects the X th secondary audio. * "X" is the number of secondary audio recorded on a disc and differs depending on the disc. <b>NOTE</b> When "BD Audio Mode" is set to "Mix Audio Output", secondary audio is output.
<b>Secondary Subtitle</b>	<b>Off</b> : Does not select the secondary subtitle. <b>1/X*</b> : Selects the first secondary subtitle. <b>2/X*</b> : Selects the second secondary subtitle. <b>X/X*</b> : Selects the X th secondary subtitle. * "X" is the number of secondary subtitle recorded on a disc and differs depending on the disc.
<b>Subtitle Style</b>	Switches the subtitle style recorded on a disc.

## Advanced version

This section describes how to enjoy files stored in a USB memory device or in a server connected via the network, or the contents of the YouTube and Netflix.

- **Advanced connections**  **page 26**
- **Playback (Advanced operation)**  **page 28**
- **How to make detailed settings**  **page 32**

Refer to the pages indicated below for information on connecting and playing back the various media and external devices.

Video File / Music File / Photo File	Connection	Playback
MEDIA PLAYER (USB memory device / DLNA server)	 page 26	 page 28
Internet	Connection	Playback
YouTube	 page 26	 page 31
Netflix	 page 26	 page 31

# Advanced connections

## Connecting to a USB memory device

MP3 or JPEG, etc. files stored on a USB memory device can be played.

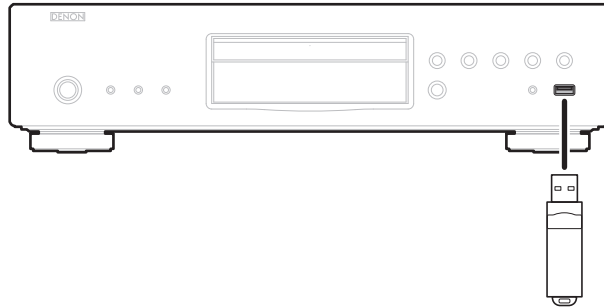

### Connecting a USB memory device

#### Insert a USB memory device into the USB port firmly.

- After the USB memory device is inserted and the power of the unit is turned on, check that the "USB" indicator on the display of the unit lights.



- For files that can be played on the unit, see page 46.
- If the "USB" indicator does not light, turn the power off, reinsert the USB memory device, and turn the unit on again.

#### NOTE

- Insert a USB memory device straight into the USB port. If the USB memory device is forcibly inserted, the unit or the device may be damaged.
- Some USB memory devices may protrude from the USB port. Do not use excessive force to insert it into the USB port, or push the protruded part forcibly.
- Do not insert an object other than a USB memory device into the USB port. It may damage the unit.
- Do not leave a USB memory device near small children. A child may swallow it.
- For connecting a USB memory device, do not use an extension cable.
- The USB port of the unit and a computer cannot be connected with a USB cable.
- Do not use for charging portable audio players or mobile phones.

### Removing a USB memory device

Press **POWER OFF** to turn the power off then remove the USB memory device from the USB port.

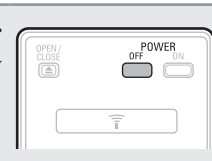

#### NOTE

- Be sure to turn the power off when inserting or removing a USB memory device. Data stored in the USB memory device or the memory of the unit may be damaged.
- In any case where data stored in a USB memory device are damaged or deleted, we will not compensate for the stored contents or any associated damage or try to restore the contents stored in a USB memory device.
- Compatibility of all USB memory devices is not guaranteed.
- For reformatting a USB memory device, format it with FAT16 or FAT32.

## Connecting to a network

When the unit is connected to the Internet, you can enjoy following functions.

- Playback of a Blu-ray disc supporting BD-LIVE™ (page 15).
- Playback of music, photos, video files stored on a device on the network (page 28).
- Playback of YouTube contents (page 31).
- Playback of Netflix contents (page 31).
- Downloading for updating the latest firmware via the network (page 34).

After connection, make settings for the Internet connection and check it before using Media Server, YouTube or Netflix.

### Cables used for connections

Audio and video cables	
HDMI cable (sold separately)	
Audio and video cable (supplied)	(White) (Red) (Yellow)
Video cable	
Component video cable (sold separately)	(Green) (Blue) (Red)
Ethernet Cable	
Ethernet cable (sold separately)	

#### NOTE

- Do not plug in the power cord until all connections have been completed.
- When making connections, also refer to the operating instructions of the other components being connected.
- Be sure to connect the left and right channels properly (left with left, right with right).
- Do not bundle power cords together with connection cables. Doing so can result in noise.

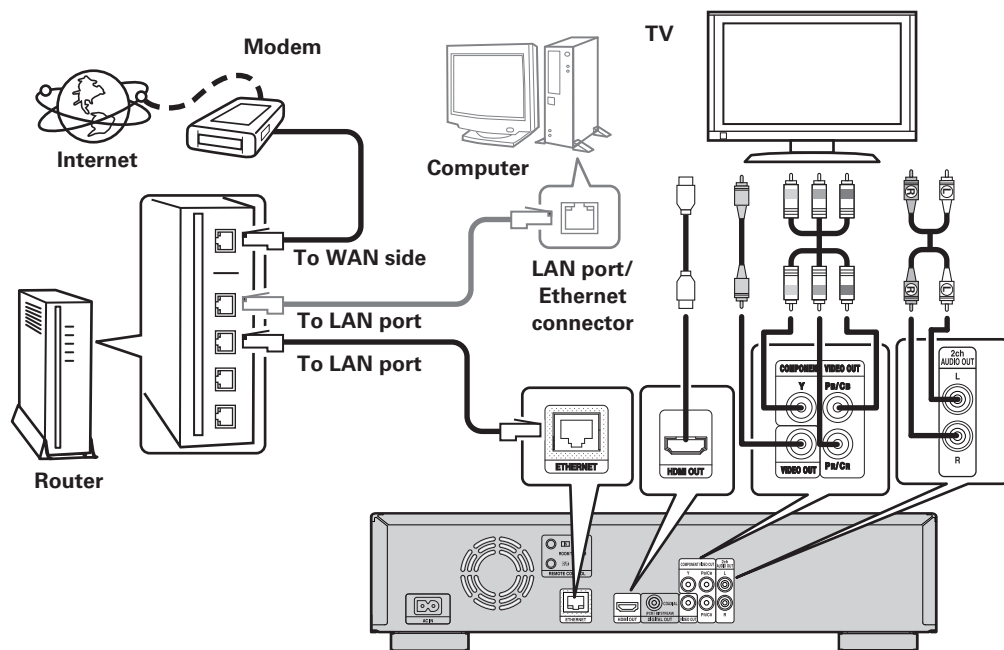

## System requirements

Internet connection via broadband.

### Modem

A device that connects to the broadband and conducts communications on the Internet. Some modems also incorporate a router.

### Router

When using the unit, we recommend a router with the following features.

- Built-in DHCP (Dynamic Host Configuration Protocol) server. This function automatically assigns an IP address on the LAN.
- Built-in 100BASE-TX switch (built-in switching hub compatible with speeds upwards of 100 Mbps)

### Computer (recommended system)

- OS  
Windows® XP Service Pack2 or more or Windows Vista
- Software  
Server software supporting Windows Media Player ver.11 or DLNA.

### Ethernet cable (CAT-5 or greater recommended)

- An ethernet cable is not included with the unit.
- Use only shielded STP or ScTP LAN cable which is available at retailer.
- We recommend a shielded straight cable (normal type) for Ethernet connections. If you use the flat type or a non-shielded cable, the noise may adversely affect other devices.

## Checking the network connection

After connection, test the Internet connection with "Connection Test" in "Network" on the GUI menu (page 36).

- If "Network is FAILED." is displayed in the test, check the IP address with "Network" in "Information" on the GUI menu, then set "DHCP" to "Manual" (page 36).



- The unit can use the DHCP function to automatically set up the network.
- When setting up your network manually, after subscribing to an ISP, make the settings according to directions in "Network" on the GUI menu (page 36).
- If you connect the unit to a network without a DHCP function, conduct IP address and other settings according to "Network" on the GUI menu (page 36).
- The unit does not support PPPoE. If you subscribe to a service that is set with PPPoE, a PPPoE compatible router is required.
- When setting up the network manually, consult with your network administrator for the settings to make.

## Registering the connected device for the network

For playing files stored on a device connected via a network, the device must have the unit registered in advance.

- For registering, refer to the operation manual supplied with the server.



For Internet connections, use an ISP (Internet Service Provider). Ask your local dealer for details.

### NOTE

- Do not connect an ETHERNET connector directly to the LAN port/Ethernet connector on your computer.
- It is necessary to subscribe to an ISP in order to connect to the Internet. If you already have a broadband connection, there is no need to subscribe anew.
- The router you can use varies with the ISP. For more information, contact your ISP or PC dealer.
- DENON assumes no responsibility whatsoever for any communication errors or problems resulting from customer's network environment or connected devices.

# Playback (Advanced operation)

This section describes the playback of files stored in the DVD, CD or USB memory device and the operation of Home menu.

- ❑ Opening the Home menu screen (👉 page 28)
- ❑ Playing files (MEDIA PLAYER) (👉 page 28)
- ❑ Playing YouTube video (👉 page 31)
- ❑ "Playing Netflix video picture" (👉 page 31)

How to make detailed settings (👉 page 32))

## Home menu screen



The unit can play music, photos, video files stored in the USB memory device connected to the front panel of the unit or on the sever connected via the network. For playback operation, use the Home menu screen.

### Opening the Home menu screen



- 1 Press HOME.**  
The Home menu is displayed on the television screen.
- 2 Press  $\Delta \nabla \triangleleft \triangleright$  to move the cursor to the menu item to be used.**
- 3 Press ENTER.**

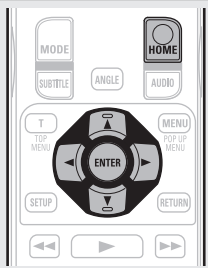

### Home menu screen

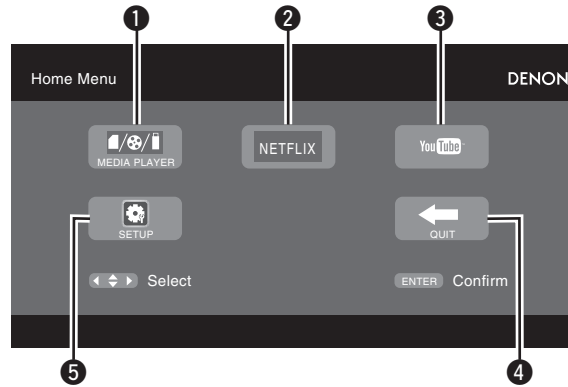

- 1 MEDIA PLAYER** (👉 page 28)  
The unit can play music, photos, video files stored on the device connected via the network or in the USB memory device connected to the front panel of the unit.
- 2 NETFLIX** (👉 page 31)  
The Netflix contents are played.
- 3 YouTube** (👉 page 31)  
The YouTube contents are played.
- 4 QUIT**  
The Home menu is closed.
- 5 SETUP** (👉 page 32)  
The GUI menu setup screen is displayed for setting the unit.

## Playing files (MEDIA PLAYER)



Files on a USB memory device, disc or a server connected to the unit are played using the Media Player of the unit.

- Before operation, start the server software of the computer (Windows Media Player, etc.), and make settings for the server contents so that files can be played via the network.
- For details, refer to the operation manual supplied with the server software.

- 1 Select "Media Player" on the Home menu screen with  $\Delta \nabla \triangleleft \triangleright$ , then press ENTER.**

Devices connected to the unit are listed on the menu screen of Media Player.



- 2 Select a device on which a file to be played is stored with  $\Delta \nabla$  then press ENTER.**

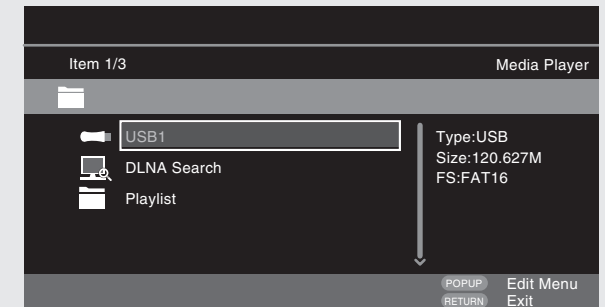

- If the server connected to the unit is not displayed on the menu screen of Media Player, select "DLNA Search" on the screen with  $\Delta \nabla$ , then press **ENTER** to search for the server.
- If the server is not displayed as a result of searching, check the connection of the server to the unit once again.
- If you perform such operations as adding or deleting a file on the connected DLNA server, information of the DLNA server may not be displayed. If this happens, turn off and on the unit's power again.





### 3 Select a folder to be played with $\Delta \nabla \triangleleft$ , then press ENTER.

- Folders classified by file type are listed on the menu screen.
- Files are classified as follows:
  - Video : DivX, MPEG, AVI, WMV
  - Music : MP3, WMA, AAC, LPCM
  - Photo : JPEG

Here, "Photo" is selected as an example.

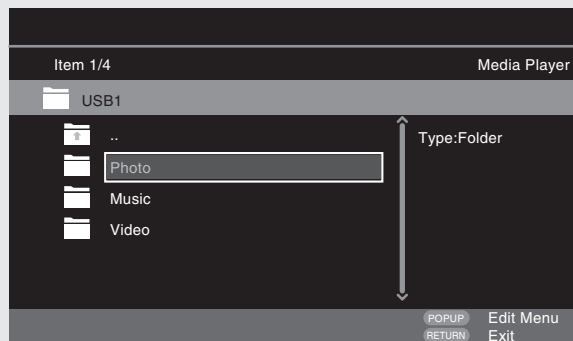

### 4 Select a file to be played on the file list on the screen with $\Delta \nabla \triangleleft$ , then press ENTER.

- Playback begins.
- A slide show begins and still images are switched at 1-10 second intervals.

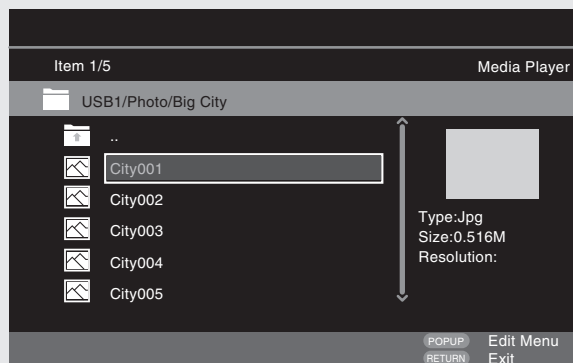

- With a large image file, the image may display for longer than the set time.
- For the file types that can be played, see "Files" (page 46).

### Changing the still image being played

- Press  $\mathbf{I} \lll, \ggg \mathbf{I}$ .
- Before playback or display of next image.

### Pausing the display

- Press  $\mathbf{II}$ .
- To cancel pause, press  $\ggg$ .

### Changing interval of slide show

Press  $\lll, \ggg$ .

### Changing the still image orientation

- Press  $\Delta \nabla \triangleleft \triangleright$ .
- $\Delta$  ..... Invert
  - $\nabla$  ..... Mirror
  - $\triangleleft$  ..... Contrarotate
  - $\triangleright$  ..... Rotate clockwise

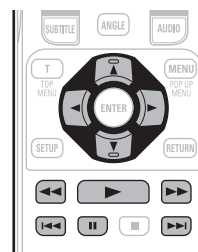

### DISC MODE

If the source of a file to be played is changed from the USB media player or server to a disc, you can also change the media with the procedures below.

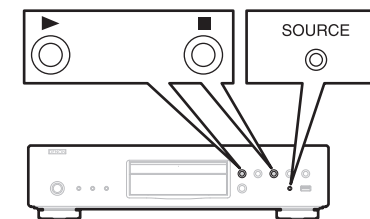

- 1 Press  $\blacksquare$ .**  
Playback of a file from a USB memory device or server stops.
  - When " $\ggg$ " flashes on the display, press  $\blacksquare$  again to turn " $\ggg$ " off.
- 2 Press SOURCE.**  
The playback mode of the unit is changed to disc mode.
- 3 Press  $\ggg$ .**  
Playback begins.

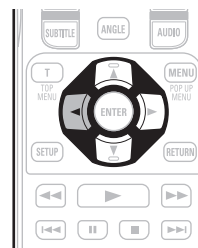

### Change the media for playback of a file

When the source of a file for playback is changed to another media, press  $\triangleleft$  to return to step 2 and select the media to be played.

The icons show the category of content applicable to each operation.



Video



Audio



Photo

For details of the media corresponding to each icon, see "Playable media" (page 45).

- ❑ **About playback information** (👉 page 13)
- ❑ **Pausing** (👉 page 17)
- ❑ **Stopping** (👉 page 17)
- ❑ **Skipping to a desired chapter/track/file** (👉 page 17)
- ❑ **Fast-forward/fast-reverse** (👉 page 17)
- ❑ **Finding specific sections with search modes** (👉 page 18)
- ❑ **Memorizing locations to replay (Marker function)** (👉 page 18)
- ❑ **Playing repeatedly (Repeat playback)** (👉 page 19)
- ❑ **Playing repeatedly between specified points (A-B repeat)** (👉 page 19)
- ❑ **Playing images frame by frame** (👉 page 19)
- ❑ **Slow-forward/slow-reverse** (👉 page 19)
- ❑ **Switching primary audio** (👉 page 19)
- ❑ **Changing the primary subtitle** (👉 page 20)
- ❑ **Switching the angle** (👉 page 20)



- Playback Video or audio may be interrupted or playback may be disabled, depending on the connection environment of devices connected via the network.
- If a file cannot be played on the unit, it may be played by converting the format on the connected device.
- The connected device cannot play data from the unit.
- It may require a little time to start playback, depending on the size of a file to be played.
- For the file types that can be played, see “Files” (👉 page 46).

## ❑ Playing playlist



Favorite files on a USB memory device, disc are played using the playlist.

### 1 Select a file to be played on the file list on the screen with $\Delta$ / $\nabla$ , then press $\triangleright$ .

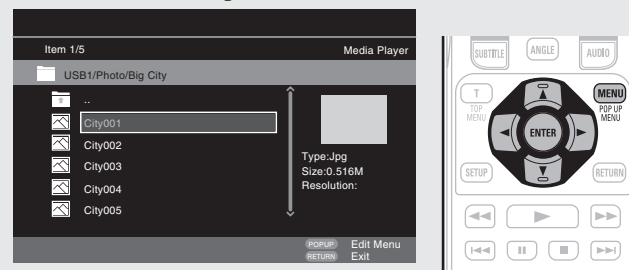

### 2 Press POP UP MENU. The menu of playlist is displayed.

### 3 Press ENTER. File is added to playlist.

### 4 Select a playlist on which a file to be played is stored with $\Delta$ / $\nabla$ / $\triangleleft$ .

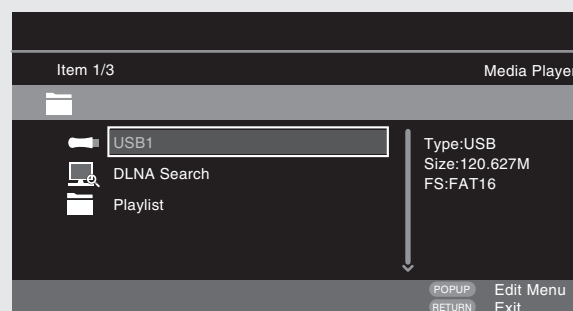

### 5 Playing files. See “Playing files (MEDIA PLAYER)” (👉 page 28)

- If the unit is set to standby, the playlist is cleared.

## ❑ Playing Kodak Picture CD



This unit can also run JPEG files stored on Kodak Picture CD. You can enjoy picture images on the display device set by playing back the picture CD. For details of Kodak picture CD, contact a shop that provides developing service of Kodak Inc.

### 1 If a Kodak Picture CD is inserted in the disc tray of the unit, a slide show begins on the screen.

### 2 Pressing $\blacksquare$ stops the slide show, and the thumbnail screen is displayed.

### 3 Use $\Delta$ / $\nabla$ / $\triangleleft$ / $\triangleright$ to select a desired picture to be played back, then press ENTER. An image will be played back from the selected track and go to the next one in turn.

### 4 Pressing POP UP MENU with the thumbnail screen displayed shows the screen for describing the playback operations.

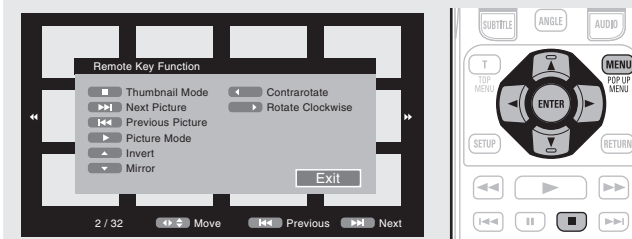

### Changing the still image being played

Press **◀◀**, **▶▶**.

- Before playback or display of next image.

### Pausing the display

Press **⏸**.

- To cancel pause, press **▶**.

### Changing interval of slide show

Press **◀◀**, **▶▶**.

### Changing the still image orientation

Press **△▽◀▷**.

- △ ..... Invert
- ▽ ..... Mirror
- ◀ ..... Contrarotate
- ▷ ..... Rotate clockwise



### Returning to the thumbnail display screen

Press **■**.

## Playing YouTube video



The operation for the video site YouTube is described here.

- 1 Press **△▽◀▷** to select “YouTube” in the “Home Menu”, and press **ENTER**.

The unit connects to YouTube.

- 2 Select the contents that you want to watch using **△▽◀▷**, and press **ENTER**.

Playback begins.

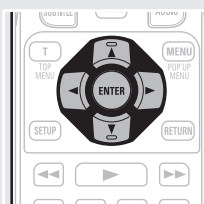

## About YouTube

- YouTube is a video file-sharing service operated and managed by YouTube Inc.
- The unit can play video hosted by YouTube.
- YouTube and the YouTube logo are the registered trademarks of Google Inc.
- The YouTube content is independently managed by YouTube, LLC.
- YouTube content may include information that may be deemed inappropriate.



- This unit must be connected to a working Internet connection in order to watch YouTube. For seamless playback of YouTube video contents, the unit needs effective speed greater than 6 Mbps for HD video contents, and greater than 2 Mbps for SD video contents, between the unit and YouTube server.
- We recommend using a broadband line such as fiber optic, ADSL, or CATV. The video content may not be displayed correctly, and / or may not be played seamlessly depending on the usage environment or communication environment, or the connection status of the line, or on the traffic status of the line.
- You cannot connect to YouTube via a proxy.
- To set the language to be displayed on the screen, configure the settings in “Language” – “GUI Language” in the GUI menu.

### NOTE

- If buttons other than **△▽◀▷** or **ENTER** are pressed while watching YouTube, the button may not work, or a different function may operate.
- Some contents cannot be played using this unit.
- Available service details and screens may change or exit without prior notice.
- We cannot accept any responsibility for the content supplied by YouTube.
- If you have any inquiries about YouTube, contact YouTube through the official homepage <http://www.youtube.com>.

## Playing Netflix video picture



The operation for the Netflix streaming service is described here.

- 1 Select “NETFLIX” on the Home menu, then press **ENTER**.

Your instant Queue screen will appear on your TV.

- 2 Use **△▽◀▷** to select highlight a movie on your instant Queue.

- 3 Press **ENTER** a title that you want to watch.

The second menu of title will appear.

- 4 Select “play” on the second menu and then press **ENTER**.

Retrieving of title will be started.

Press **△** to return to your instant Queue.



- For using “Netflix”, Internet connection is required. It is recommended to use a broadband line (effective speed 6 Mbps or more) such as FITH (optical) ADSL, CATV, etc.
- Even if the line speed is sufficient to make it viewable, pictures may be unstable, interrupted, or not viewed depending on the usage environment, communication environment, connecting line conditions, etc.
- The connection of Netflix may not be connected via proxy.
- For the usage conditions for Netflix, contact Netflix.

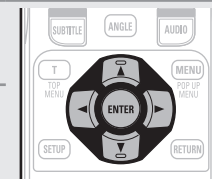

# How to make detailed settings

## Menu map

Pressing **SETUP** displays the GUI menu. From this menu, you can move to various setting screens.



### General Setting (page 34)

Settings for screen display, etc. are made.

#### System

- Screen Saver
- Auto Power
- Power Saving
- HDMI Control
- HDMI Power Off Control
- Initialize
- Firmware Update Mode
- Update Notification
- BD Data Utility

#### Language

- GUI Language
- Disc Menus
- Dialog
- Subtitle

#### Ratings

- Change Password
- BD Rating Level
- DVD Rating Level
- Country Code

#### Network

- Internet Connection
- Information
- Connection Test
- DHCP
- BD-LIVE Connection
- Proxy Setting

#### Others

- Closed Caption
- Angle Mark
- PIP Mark
- Secondary Audio Mark
- DivX Registration
- Remote ID
- Receive Legacy Remocon
- Netflix Deactivate

### Video Setting (page 37)

Settings for a television and HDMI are made.

#### TV

- TV Aspect
- Wallpaper
- Progressive Mode

#### HDMI

- Color Space
- HDMI Deep Color

### Audio Setting (page 38)

Settings for audio output are made.

#### Audio Output

- Coaxial
- HDMI
- Down Sampling
- DRC

### System Information (page 39)

MAC Address is displayed.

Display MAC Address.

# GUI menu operation

## 1 Press **SETUP**.

The GUI menu is displayed on the TV screen.

- The GUI menu is also displayed when you press **SETUP** of the Home menu.



## 2 Press **△▽◀▶** to select the menu to be set or operated.

- To return to the previous item, press **◀**.

## 3 Press **ENTER** to enter a setting.



Text colors of selected items of the GUI menu are as follows:

- White : These items can be selected.
- Gray : These items cannot be selected.

### NOTE

You must use the GUI menu to make settings or operate while a disc or USB memory device is not inserted. In cases in which the resume function is activated, you may not make correct settings.

## Exiting the GUI menu

Press **SETUP** while the GUI menu is displayed.

- The GUI menu display disappears.

## Examples of GUI menu screen displays

Typical examples are described below.

### Menu selection screen (Top menu)

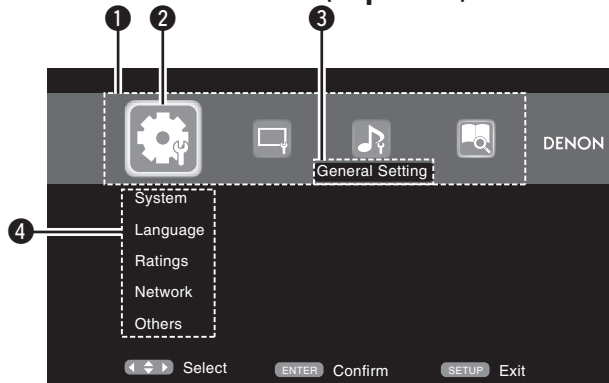

- ① List of GUI menu setup icons
- ② Currently selected setup icon
- ③ Currently selected setup item
- ④ List of currently selected setup items

Press **◀▶** to select "⚙️" and then press **▽**.  
(Or press **ENTER**.)

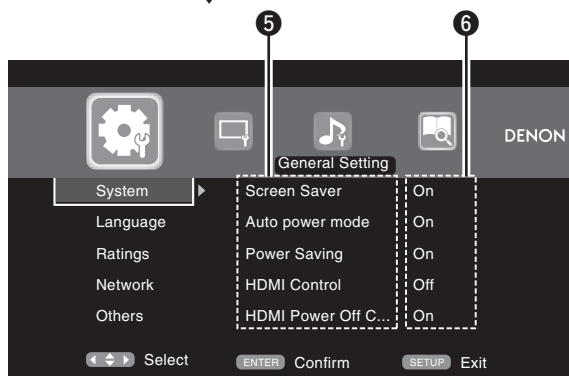

- ⑤ List of items of currently selected advanced settings
- ⑥ Currently selected advanced settings

### List of items

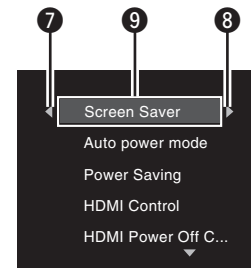

- ⑦ Returns to the previous item. Use **◀** to switch.
- ⑧ Switch to the next item. Use **▶** to switch.
- ⑨ Selected item. Switch the selected item using **△▽**.



# General Setting

Settings for system, language, parental lock, network, etc. can be made.



## System

Default settings are underlined.

Set the following settings.

- Screen saver settings
- Power saving mode settings
- HDMI control function settings
- Initialize settings
- Firmware update from the Internet
- BD-LIVE Memory switching settings

Setting items	Setting details
<b>Screen Saver</b> Sets the screensaver.	<b>On</b> : The screensaver function activates when stop or pause status continues for about three minutes. <b>Off</b> : Does not use the screensaver.
<b>Auto Power Mode</b> This setting automatically sets the power to standby.	<b>On</b> : This setting automatically sets the power to standby if any of the following states continues for approximately 30 minutes. <ul style="list-style-type: none"> <li>• Disc not loaded</li> <li>• Playback stopped</li> <li>• Stopped due to the resume function</li> </ul> <b>Off</b> : Does not use the auto power mode.
<b>Power Saving</b> Sets to power saving mode during standby.	<b>Power Saving Standby</b> : This is the lowest power consumption mode. During standby, operations are not accepted via HDMI control. Power indicator status in standby mode : Off <b>Normal Standby</b> : During standby, operations are accepted via HDMI control. Power consumption is slightly higher at this time. Power indicator status in standby mode : Red
<b>HDMI Control</b> Links the unit and a device connected with an HDMI cable that supports HDMI control.	<b>On</b> : Links with the device connected to HDMI. <b>Off</b> : Disables the HDMI control function.  <ul style="list-style-type: none"> <li>• For the HDMI control function to operate, it is necessary for the unit or HDMI-compatible TV connected to the unit to have an HDMI connection.</li> <li>• Refer to "HDMI control functions" (page 21) for more information on HDMI control functions.</li> <li>• After the "HDMI Control" setting has been changed, always turn off the power to the connected equipment and then turn it back on.</li> </ul>
<b>HDMI Power Off Control</b> Links the power of the unit and a device connected with an HDMI cable that supports HDMI control.	<b>On</b> : Turns the unit's power to standby through linkage to the TV. <b>Off</b> : Does not turn the unit's power to standby through linkage to the TV.
<b>Initialize</b> All settings including audio mode and picture quality are set to default settings.	<b>Cancel</b> : Does not initialize. <b>OK</b> : Executes initialization.

Setting items	Setting details
<b>Firmware Update</b> Updates the firmware of the unit via the Internet.	<b>Check for Update</b> : Checks if a newer version of firmware exists. Press <b>ENTER</b> to see the approximate amount of time required for the update. If the firmware is already updated to the latest version, the firmware updating operation starts after you press <b>ENTER</b> . When the update starts, a progress bar and the remaining time required to complete the update are displayed on the television screen. When the update completes, the units turns on again and returns to the normal state.
<b>Update Notification</b> Displays the message for updating on a television screen just after the power is turned on.	<b>On</b> : The message for updating is displayed on a television screen. <b>Off</b> : The message for updating is not displayed on a television screen.
<b>BD Data Utility</b> Initializes the BD data stored in the built-in memory or external memory used for BD-Live.	<b>BD Data Information</b> : The BD data used for BD-Live are initialized. The space remaining in the memory being used is displayed. <b>FMT BD Data</b> : Initializes the space for BD data being used for BD-Live.  This operation deletes all data. When a USB memory device that stores the data is inserted, never execute this operation. <b>BD-Live Memory</b> : Built-in memory or external memory is selected for the BD-Live memory. <ul style="list-style-type: none"> <li>• <b>Internal</b> : The built-in memory is used.</li> <li>• <b>External</b> : The USB memory device inserted in the unit is used.</li> </ul>  If the file size used for BD-Live will exceed the remaining built-in memory capacity, select "External" (page 15).

### NOTE

When the following message is displayed after "Firmware Update" (page 34), follow the instructions in the message to perform operations.

**"Disconnect the power plug of the unit from the outlet, wait approximately 30 seconds, and then insert the plug again before use."**



## Language

Default settings are underlined.

Set the playback audio, subtitles, and menu display languages.

Setting items	Setting details
<b>GUI Language</b> Sets the GUI language.	<u>English</u> / Français / Español
<b>Disc Menus</b> Sets the language used for BD or DVD menus.	<u>English</u> / French / Chinese / Spanish / German / Italian / Dutch / Portuguese / Danish / Swedish / Finnish / Norwegian / Russian / Korean / Japanese / More*
<b>Dialog</b> Sets the dialog used to play BD or DVD.	<u>English</u> / French / Chinese / Spanish / German / Italian / Dutch / Portuguese / Danish / Swedish / Finnish / Norwegian / Russian / Korean / Japanese / More*
<b>Subtitle</b> Sets the subtitle language used to play BD or DVD.	<u>Off</u> / English / French / Chinese / Spanish / German / Italian / Dutch / Portuguese / Danish / Swedish / Finnish / Norwegian / Russian / Korean / Japanese / More*  • <b>Off</b> : No subtitles displayed.

\*Press More to select a language other than those displayed in the list.

## Ratings

Default settings are underlined.

Set the BD and DVD playback settings and password settings.

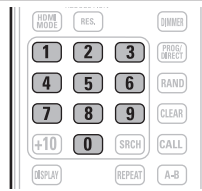

Setting items	Setting details
<b>Change Password</b> Sets the password for changing the parental control level and parental control country code of BD and DVD.	<b>Change</b> : Changes the password. Use <b>0 – 9</b> to enter a password and then press <b>ENTER</b> to finalize it. The default setting is "0000" 
<b>BD Rating Level</b> Sets the parental level for playing BD.	<b>Level 0 – 254</b> : Sets the age allowed to play back media. Restricts playback of discs with relevant parental control. <b>No Limit</b> : Does not restrict playing of BD.
<b>DVD Rating Level</b> Sets the parental level for playing DVD.	<b>Level1 – 8</b> : Sets the parental level for playing DVD. <b>Lock All</b> : Restricts playing of all DVD. <b>No Limit</b> : Does not restrict playing of DVD.
<b>Country Code</b> Sets the standard country parental control. Applies the parental level of the set country.	Initial setting is United States. Select the parental lock code for another country with $\Delta \nabla$ .



# Network

Default settings are underlined.

Set Internet connection settings and BD-LIVE settings.

Setting items	Setting details
<b>Internet Connection</b> Sets whether the Internet connection is to be used or not.	<b>Enable</b> : The Internet connection is to be used. <b>Disable</b> : The Internet connection is not to be used.
<b>Information</b> Displays the network information such as the IP address, subnet mask, etc.	Displays the network information shown below. <ul style="list-style-type: none"> <li>• Address type</li> <li>• IP Address</li> <li>• Subnet Mask</li> <li>• Default Gateway</li> <li>• Primary DNS</li> <li>• Secondary DNS</li> </ul>
<b>Connection Test</b> Performs the network connection test.	Perform the Internet connection test. <ul style="list-style-type: none"> <li>• It is recommended to perform the connection test for the first Internet connection, or after the IP address or the settings for the network are changed.</li> <li>• If connection is not completed, a message is displayed. Check the connection settings and connection environment.</li> </ul>
<b>DHCP</b> Sets how to perform network configuration, automatically or manually.  <p>Since the factory default setting is "Auto", you do not need to set items such as the IP address if the DHCP server of the broadband router is set to "Enable". Configure a proxy server if necessary.</p>	<b>Auto</b> : Automatically configures the network via the DHCP function. <b>Manual</b> : When connecting to a network that lacks the DHCP function, manually configure the following network settings. Consult with the ISP or your network administrator for what settings to make. After use ▾ to clear value, use <b>0-9</b> to enter values and then press <b>ENTER</b> to finalize them.  <ul style="list-style-type: none"> <li>• <b>IP Address</b> : Manually configure the IP address.</li> <li>• <b>Subnet Mask</b> : If a xDSL modem or terminal adaptor is directly connected to the unit, enter the subnet mask provided by the ISP, usually in a document. Usually, "255.255.255.0" is set.</li> <li>• <b>Default Gateway</b> : If the device is connected to a gateway (router), enter its IP address.</li> <li>• <b>Primary DNS</b> : Enter the primary DNS.</li> <li>• <b>Secondary DNS</b> : Enter the secondary DNS.</li> </ul>
<b>BD-LIVE Connection</b> Limits the access rights for the content on a BD-LIVE connection.	<b>Permitted</b> : All Internet accesses from BD-LIVE are permitted. <b>Partial Permitted</b> : Internet accesses from the certified BD-LIVE are permitted. <b>Prohibited</b> : All Internet accesses from BD-LIVE are prohibited.

Setting items	Setting details
<b>Proxy Setting</b> Setting for connecting to the Internet via a proxy server.	<b>Disable</b> : Does not use a proxy server. <b>Enable</b> : Uses the proxy server. <ul style="list-style-type: none"> <li>• Proxy host: If Enable is selected for Proxy Setting, enter the proxy host from the virtual keyboard and press <b>ENTER</b> to register it.</li> <li>• Proxy port: If Enable is selected for Proxy Setting, enter the proxy port from the <b>0-9</b> and press <b>ENTER</b> to register it.</li> </ul>

**Network proxy input screen (with virtual keyboard)**

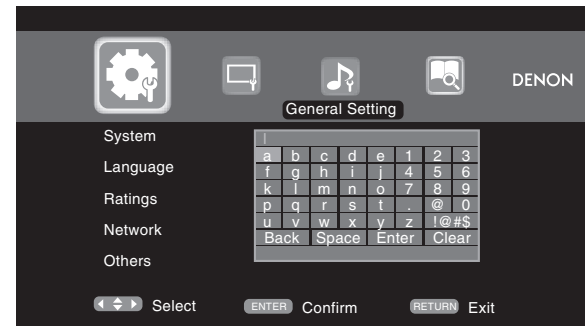

Displaying the menu  
Cancel the menu



Move the cursor  
(Up/Down/Left/Right)



Decision the setting



Return to previous menu



## General Setting

## Others

Default settings are underlined.

Set other functions.

Setting items	Setting details
<b>Closed Caption</b> This setting outputs a subtitles signal to a closed caption decoder (sold separately).	<b>Off</b> : Does not output the closed caption (subtitle) signal. <b>On</b> : Outputs the closed caption (subtitle) signal.
<b>Angle Mark</b> For making settings for the angle mark displayed in playback.	If multiple angle marks are recorded on the disc being played, an angle mark is displayed while the scene including an angle is being played. <b>Off</b> : An angle mark is not displayed. <b>On</b> : An angle mark is displayed.
<b>PIP Mark</b> For making settings for the PIP mark displayed in playback.	If secondary video is recorded on the disc being played, a PIP mark is displayed while the scene including secondary video is being played. <b>Off</b> : A PIP mark is not displayed. <b>On</b> : A PIP mark is displayed.
<b>Secondary Audio Mark</b> For making settings for the secondary audio mark displayed in playback.	If secondary audio is recorded on the disc being played, a secondary audio mark is displayed while the scene including secondary audio is being played. <b>Off</b> : A secondary audio mark is not displayed. <b>On</b> : A secondary audio mark is displayed.
<b>DivX Registration</b> Displays the DivX® registration code.	<b>Show Code</b> : Displays the DivX® registration code.
<b>Remote ID (Unit side)</b> Sets the remote control ID (page 44).	Switches the unit's remote control ID code when other DENON BD players are in the vicinity. <b>DENON 1</b> : Selects DENON 1. Set to "DENON 1" also on the remote control. <b>DENON 2</b> : Selects DENON 2. Set to "DENON 2" also on the remote control.
<b>Receive Legacy Remocon</b> For making settings for the Legacy remote control reception.	Set whether or not to accept remote control signals of a DENON DVD player or other device. <b>On</b> : Accepts. <b>Off</b> : Does not accept.
<b>Netflix Deactivate</b> For deactivating the Netflix audience function.	<b>No</b> : For activating the Netflix audience function. <b>Yes</b> : For deactivating the Netflix audience function. <b>Netflix ESN</b> : A unique Netflix ESN (Electric Serial Number) that can use Netflix stream service is displayed.



## Video Setting

Sets up TV connection, HDMI connection, and 3D video software playback.

## TV

Default settings are underlined.

Set the video output signal according to the connected TV.

Setting items	Setting details
<b>TV Aspect (Aspect ratio)</b> Set the screen type and display mode of the TV.	<b>16:9 Squeeze Auto</b> : Outputs to a wide screen TV. For 4:3 video, displays in the center of the screen without changing the aspect ratio.*1 <b>WIDE (16:9)</b> : Outputs to a wide-screen TV. <b>4:3 PS</b> : Outputs to a 4:3 TV. For wide video, trim the left and right side of the image and display in 4:3 aspect ratio.*2 <b>4:3 LB</b> : Outputs to a 4:3 TV. Displays all of the wide video.
<b>Wallpaper</b> Setting for displaying the background when playback is stopped.	<b>Picture</b> : Displays the DENON logo. <b>Black</b> : Sets the background to black. <b>Gray</b> : Sets the background to gray. <b>Blue</b> : Sets the background to blue.
<b>Progressive Mode</b> *3 Sets an appropriate progressive conversion mode for the source video material.	<b>Auto</b> : Detects the type of video material and automatically switches the mode. Normally, this setting is used. <b>Video</b> : Suitable for playing video material discs. <b>Film</b> : Suitable for playing film material discs.

\*1 This has no effect with the video output.

\*2 Depending on the video content, even though you set it to 4:3 PS (Pan Scan), the content may be output in 4:3 LB (Letter Box).

\*3 This mode is activated for the video source of 480i/576i.

## HDMI

Default settings are underlined.

Set the HDMI output signal.

Setting items	Setting details
<b>Color Space</b> Sets the video signal system to be output from HDMI.	<b>YCbCr</b> : Outputs using the color difference video system (16 (black) to 235 (white)). <b>RGB</b> : Outputs using the RGB video system (16 (black) to 235 (white)).
<b>HDMI Deep Color</b> Sets the HDMI terminal to output Deep Color. Expands the color depth (number of used colors) of the HDMI video signal, enabling playback with more natural colors and free of streaking.	<b>Auto</b> : Deep Color is automatically output when the connected HDMI device supports Deep Color. <b>Off</b> : No Deep Color output.

## Remote control operation buttons

Displaying the menu  
Cancel the menuMove the cursor  
(Up/Down/Left/Right)

Decision the setting



Return to previous menu

### 3D

Default settings are underlined.

Sets up 3D video software playback.

Setting items	Setting details
<b>3D Output Setting</b> Sets up video outputs for 3D video playback (only for HDMI).	<b>Auto</b> : Automatically determines whether the video software is 3D or 2D and plays it back. <ul style="list-style-type: none"> <li>• When you play 3D video, 3D and 2D video parts are played back as 3D and 2D, respectively.</li> <li>• Normally, use this setting.</li> </ul> <b>Off</b> : Always outputs 2D video signals.
<b>TV Screen Size Setting</b> Sets up the screen size of your 3D enabled TV.	Use $\Delta \nabla \triangleleft \triangleright$ or <b>0 - 9</b> to enter three digits for the screen size of your TV in the setting screen, and press <b>ENTER</b> for confirmation. <ul style="list-style-type: none"> <li>• The default setting is "046" (46" TV screen size).</li> </ul> <div style="border: 1px solid black; border-radius: 5px; padding: 2px; display: inline-block; margin-top: 5px;"><b>NOTE</b></div> Set up the correct size, otherwise you may not be able to view 3D video properly.



3D video playback operations may differ according to the disc to be used. Refer to the instruction manual supplied with your disc.

**NOTE**

When passing 3D video signals output from this device through an AV receiver to a 3D enabled TV, the AV receiver must also be compatible with inputting / outputting 3D video signals.

To view 3D video, use a 3D enabled TV.

- To connect the unit with a 3D enabled TV, use a high speed HDMI cable.
- During 3D playback, you cannot adjust "Video Resolution" (page 22), "HDMI output Settings" (page 22), or "Adjusting the picture quality" (page 23).





## Audio Setting

Settings for audio output are made.

### Audio Output

Default settings are underlined.

Set the audio output.

Setting items	Setting details
<b>Coaxial</b> For selecting the format output from the digital audio output terminals.	<b>Bitstream</b> : For selecting if the device connected to the unit supports Dolby Digital or DTS Digital Surround. <b>PCM</b> : For selecting when the device connected to the unit does not support Dolby Digital or DTS Digital Surround. <b>Off</b> : For outputting no audio signal from the digital audio output terminal of the unit.  For converting audio signals, see "About digital signal audio output" (page 49).
<b>HDMI</b> For selecting the format output from the HDMI output terminals.	<b>Bitstream</b> : For selecting when the device connected to the unit supports Dolby TrueHD/Dolby Digital Plus/Dolby Digital or DTS-HD/DTS Digital Surround. The output format is automatically selected according to the audio format or the number of channels supported by the connected HDMI device. <b>PCM</b> : For selecting when a device connected to the unit does not support Dolby TrueHD/Dolby Digital Plus/Dolby Digital or DTS-HD/DTS Digital Surround. <b>Off</b> : For outputting no audio signal from the HDMI output terminal of the unit.  For converting audio signals, see "About digital signal audio output" (page 49). <div style="border: 1px solid black; border-radius: 5px; padding: 2px; display: inline-block; margin-top: 5px;"><b>NOTE</b></div> If "BD audio mode" is set to "HD Audio Output" with <b>MODE</b> on the remote control, BD secondary audio and interactive audio are not output.

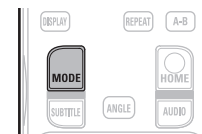

Displaying the menu  
Cancel the menu



Move the cursor  
(Up/Down/Left/Right)



Decision the setting



Return to previous menu

## Audio Setting

Setting items	Setting details
<b>Down Sampling</b> For selecting the sampling rate output from the digital audio output terminal.	Refer to the operation manual for the device connected to the unit, and make settings depending on the connected device. <b>48 kHz / 96 kHz / 192 kHz</b> <div style="border: 1px solid black; border-radius: 10px; padding: 2px; display: inline-block; margin: 5px 0;"><b>NOTE</b></div> <ul style="list-style-type: none"> <li>• For rights-protected content, the audio signal is down-sampled to 48 kHz, 16-bits, and output.</li> <li>• If the connected device does not support the sampling rate of 96 kHz or 192 kHz and the settings for the unit is made as 96 kHz or 192 kHz, much noise may be generated from the connected device.</li> </ul>
<b>DRC</b> Compresses the dynamic range of Dolby TruHD/Dolby Digital Plus/Dolby Digital Audio.	<b>Off</b> : Dynamic range is not compressed. <b>On</b> : Dynamic range is compressed. <b>Auto</b> : Dynamic range of Dolby TrueHD audio is automatically compressed according to the material. Audio of Dolby TrueHD only is compressed.  This setting compensates high volume to low and low volume to high when high volume is not desired at night.



## System Information

MAC address is displayed.







Setting items	Setting details
<b>MAC Address</b> Displays the MAC address.	Displays the MAC address.



## Information

---

This section list various information related to this unit.  
Please refer to this information as needed.

- Part names and functions  page 41
- About media  page 45
- Other information  page 49
- Troubleshooting  page 53
- Specifications  page 56
- Index  page 57

# Part names and functions

## Front panel

For buttons not explained here, see the page indicated in parentheses ( ).

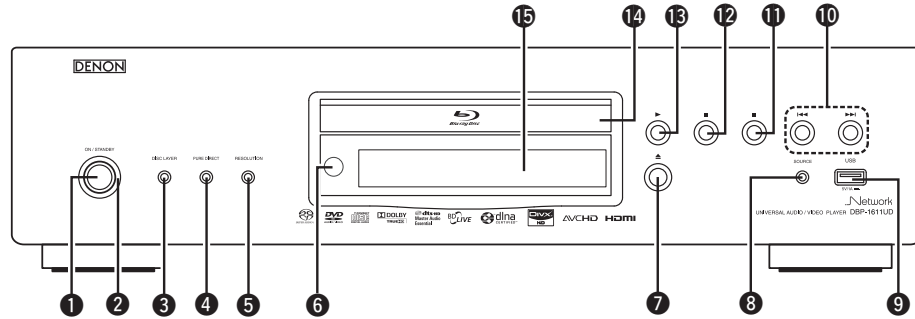



- 1 Power operation button (ON/STANDBY)** ..... (5, 7)  
Turns power to this unit on and off (standby).
- 2 Power indicator** ..... (5, 7)
- 3 DISC LAYER button** ..... (14 – 16)
- 4 PURE DIRECT button** ..... (21)
- 5 RESOLUTION button** ..... (11, 22)
- 6 Remote control sensor** ..... (44)
- 7 Disc tray open/close button** (▲) ..... (6, 14 – 16)
- 8 SOURCE button** ..... (29)
- 9 USB port** ..... (26)
- 10 Reverse-skip/Forward-skip buttons** (◀◀, ▶▶) ..... (17)
- 11 Stop button** (■) ..... (17)
- 12 Pause/Still button** (||) ..... (17)
- 13 Play button** (▶) ..... (6, 14 – 16)
- 14 Disc tray** ..... (6)
- 15 Display** ..... (41)

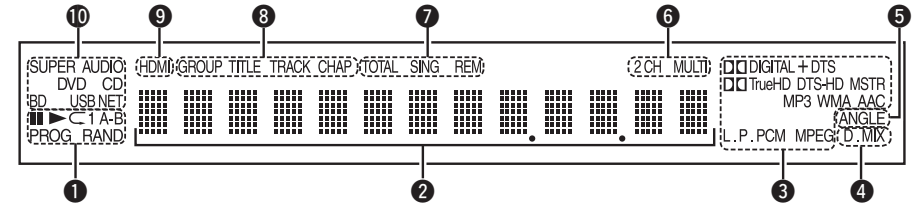

If **7** or **13** is pressed when the power is in standby, the power is turned on.

## Display



- 1 Playback mode indicators**  
▶ : During Playback  
|| : During pause and step-by-step playback  
PROG : During program playback  
RAND : During random playback  
◁ 1 A-B : During repeat playback
- 2 Information display**  
Displays various information or playback elapsed time and so on of the disc.
- 3 Playback format indicators**
- 4 Downmix indicator**  
Displayed when playing back downmix permitted audio.
- 5 Angle information indicator**  
Displayed when a scene on the currently playing disc has been shot at various angles.
- 6 Audio channel indicators**  
Displays the number of audio signal channels during playback.  
2CH : 2-channel playback  
MULTI : Multi-channel playback
- 7 Time mode indicators**  
TOTAL : Total time of Super Audio CD and CD  
SING : Elapsed time of title/chapter/track/file being played  
REM : Remaining time of title/chapter/track/file being played
- 8 Group/Title/Track/Chapter indicators**
- 9 HDMI output indicator**  
Display when HDMI video or audio signals are being output.  
  
Does not display when the HDMI cable is not correctly connected or when the HDMI connection is not verified.
- 10 Media indicators**  
BD : BD  
DVD : DVD-Video, DVD-R/+R/-RW/+RW  
DVD AUDIO : DVD-Audio  
SUPER AUDIO CD : Super Audio CD  
CD : CD  
USB : USB memory device  
NET : NETWORK  
Displays the inserted media and contents via Network.

# Rear panel

For buttons not explained here, see the page indicated in parentheses ( ).

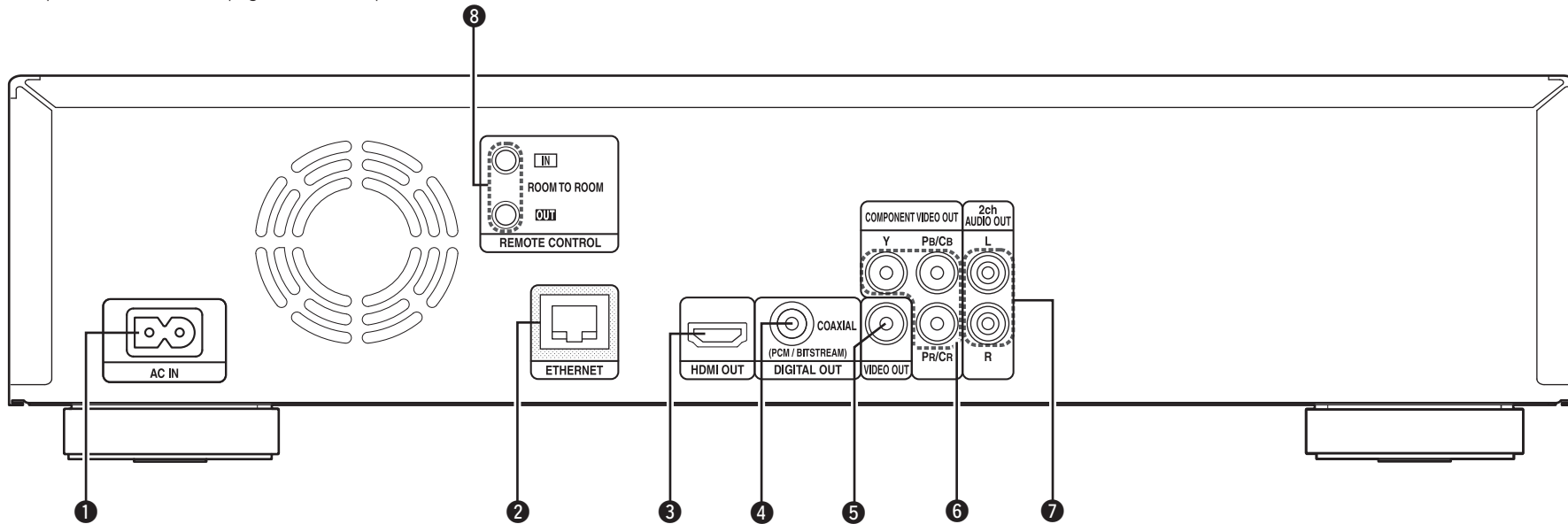

- ① AC inlet (AC IN)..... (5)
- ② ETHERNET connector ..... (27)
- ③ HDMI OUT connector ..... (4)
- ④ DIGITAL OUT COAXIAL connector ..... (10, 12)
- ⑤ VIDEO OUT connector .....(9 – 11)
- ⑥ COMPONENT VIDEO OUT connectors.....(9 – 11)

- ⑦ 2ch AUDIO OUT connectors ..... (11, 12)  
For software recorded in multi-channel, analog signals that have been down-mixed into 2 channels are output.
- ⑧ ROOM TO ROOM IN/OUT jacks  
Extension jack for future use.

**NOTE**

- Do not touch the inner pins of the connectors on the rear panel. Electrostatic discharge may cause permanent damage to the unit.
- Do not put your finger or foreign object in the fan opening. Doing so could cause injury or unit failure.

# Remote control

For buttons not explained here, see the page indicated in parentheses ( ).

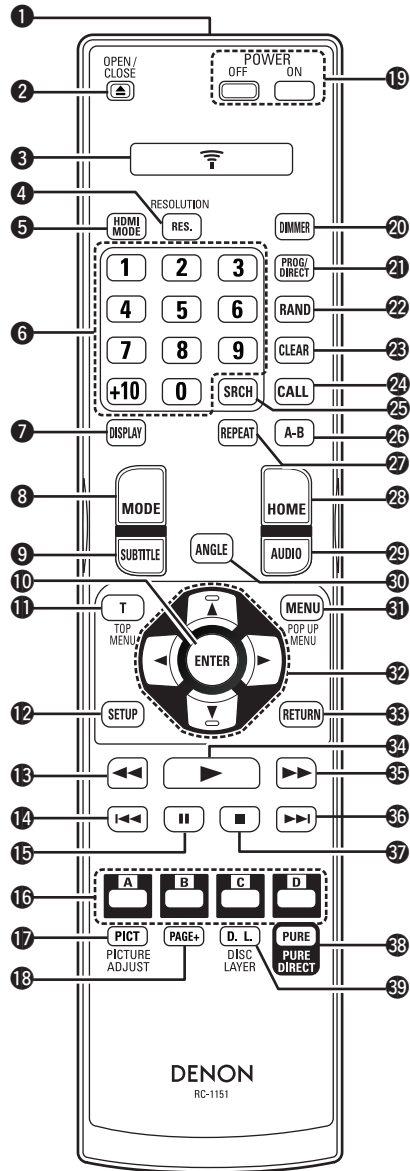

1 Remote control signal transmitter	44
2 Disc tray OPEN/CLOSE button (▲)	(6, 14 - 16)
3 Remote control signal transmission/status display	(44)
4 RESOLUTION button (RES.)	(11, 22)
5 HDMI MODE button	(22)
6 Number buttons (0 - 9, +10)	(18, 20)
7 DISPLAY button	(13)
8 MODE button	(6, 24)
9 SUBTITLE button	(20)
10 ENTER button	(18, 20, 33)
11 TOP MENU button (T)	(14)
12 SETUP button	(33)
13 Fast-reversing button (◀◀)	(17)
14 Reverse-skip button ( ◀◀)	(17)
15 Pause/Still button (  )	(17)
16 A/B/C/D buttons	
17 PICTURE ADJUST button (PICT)	(23)
18 PAGE + button	(16)
19 POWER buttons (POWER OFF/ON)	(5)
20 DIMMER button	(21)
21 Program/Direct button (PROG/DIRECT)	(20)
22 Random button (RAND)	(20)
23 CLEAR button	(18, 20)
24 CALL button	(20)
25 SEARCH mode button (SRCH)	(18)
26 A-B Repeat button (A-B)	(19)
27 REPEAT button	(19)
28 HOME button	(28)
29 AUDIO button	(19)
30 ANGLE button	(20)
31 MENU/POP UP MENU button	(14)
32 Cursor buttons (△▽◀▷)	(14, 33)

33 RETURN button	(29, 30)
34 Play button (▶)	(6, 14 - 16)
35 Fast-forwarding button (▶▶)	(17)
36 Forward-skip button (▶▶ )	(17)
37 Stop button (■)	(17)
38 PURE DIRECT button (PURE)	(21)
39 DISC LAYER button (D. L)	(14 - 16)

**NOTE**

- When power is in standby, press 2 and 34 to turn the power on.
- You can use 16 when operating the BD pop up menu screen, etc.

## Inserting the batteries

- Slide the rear lid in the direction of the arrow and remove it.
- Load the two batteries properly as indicated by the marks in the battery compartment.

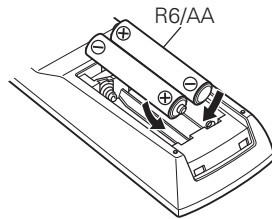
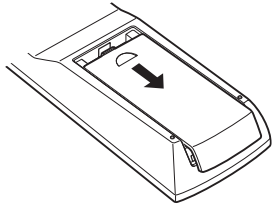

- Put the rear cover back on.



If the battery level is low, the remote control signal transmission/status display flashes 5 times when a button is pressed. In this case, replace the batteries soon.

- If the batteries are completely exhausted, the remote control signal transmission/status indicator goes dark.

### NOTE

- Insert the specified batteries in the remote control.
- Replace the batteries with new ones if the set does not operate even when the remote control is operated close to the unit. (The supplied batteries are only for verifying operation.)
- When inserting the batteries, be sure to do so in the proper direction, following the ⊕ and ⊖ marks in the battery compartment.
- To prevent damage or leakage of battery fluid:
  - Do not use a new battery together with an old one.
  - Do not use two different types of batteries.
  - Do not attempt to charge dry batteries.
  - Do not short-circuit, disassemble, heat or dispose of batteries in flames.
  - Do not keep the battery in a place exposed to direct sunlight or in places with extremely high temperatures, such as near a heater.
- If the battery fluid should leak, carefully wipe the fluid off the inside of the battery compartment and insert new batteries.
- Remove the batteries from the remote control if it will not be in use for long periods.
- Used batteries should be disposed of in accordance with the local regulations regarding battery disposal.

## Operating range of the remote control

Point the remote control at the remote sensor when operating it.

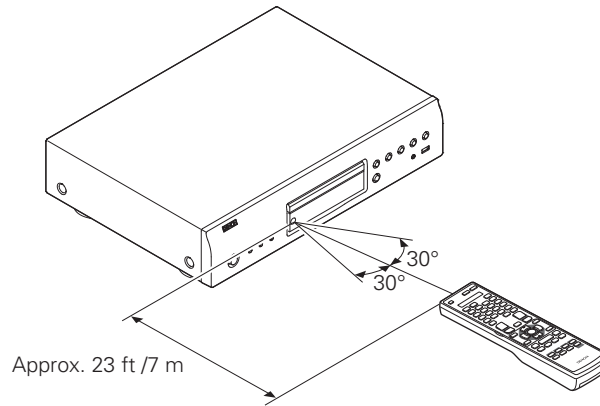

### NOTE

The set may function improperly or the remote control may not operate if the remote control sensor is exposed to direct sunlight, strong artificial light from an inverter type fluorescent lamp or infrared light.

## Remote control settings (remote control side)

**Switches when this unit remote control operates another DENON BD players in the vicinity.**

Set the remote control code simultaneously on the unit, too (☞ page 37 "Remote ID").

### 1 Hold POWER ON and OPEN/CLOSE pressed simultaneously.

While these buttons are held pressed, the remote control signal transmission/status display flashes twice, and the remote control enters Setup mode.

- When the number button "1" is pressed, the remote control ID is set to "DENON 1".  
When the number button "2" is pressed, the remote control ID is set to "DENON 2".

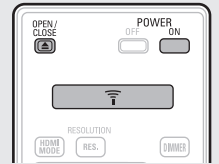

When number key input is completed and the remote control signal transmission/status display flashes twice, the settings for the remote control are completed.



If the signal code of the remote control does not match the signal code of the unit, the remote control code set on the unit is shown on the display.

### [Example]

If the code setting on the unit is "DENON 1", and the setting on the remote control is "2", "PLAYER 1" is shown on the display.

### NOTE

- If you made the remote control settings incorrectly, the remote control signal transmission/status display flashes for 2 seconds, and then goes off. If this happens, the settings are incorrect and retry the settings.
- Match the signal code of the remote control with the signal code of the unit. If the remote control code is different, you cannot operate the this unit with the remote control.
- Even if you change the remote control code, set the GUI menu "Others"- "Receive Legacy Remocon" (☞ page 37) to "Off" when operating this unit with a remote control other than DENON's.



# About media

## Playable media

### Discs

Playable media	Playable formats/modes	Playable region codes	Symbols used in this Owner's Manual
BD-Video *1, *2		-	Discs with
BD-R *3		-	
BD-RE *3		-	
DVD-Audio *1		-	
DVD-Video *1, *2		Include region	
DVD-R, DVD+R		Video mode, AVCHD format	
DVD-RW, DVD+RW	 		
Super Audio CD		-	
CD		-	
CD-R			
CD-RW			

### NOTE

- A disc may not be accessible or may play incorrectly due to audio and video interruptions, etc., depending on the recording conditions when recorded with a BD recorder or DVD recorder.
- Unfinalised DVD-R/-RW/+R/+RW, and CD-R/-RW discs may not play back. Finalize discs before playing.



The following discs will not play back on this unit.

- BD-RE Ver1.0 (BD disc with cartridge)
- BD-ROM/BD-R/BD-RE discs containing recorded movie, still image, audio, and/or other, files
- BDXL
- HD DVD
- DVD-RAM
- CDV (Only the audio part can be played)
- CD-G (Only the audio signals can be output)
- Non-standard CD (CD with copy protection, etc.)
- Unauthorised disc (Pirated disc)
- Disc with recording area less than 55 mm in diameter
- Video Single Disc (VSD) / CVD/ Video CD / Super Video CD / CompactDisc-Interactive (CD-I) / Photo CD

- \*1 BD-Video/DVD-Audio/DVD-Video discs may not operate as described in this manual due to menu structure.
  - \*2 BD players and BD-Video discs, and BD/DVD players and DVD-Video discs each have their region codes (codes assigned for each region). Playback is not possible if the codes do not match.
  - \*3 Compatibility of a Blu-ray Disc as the specifications for Blu-ray Discs are new and advance day by day, discs of some types or versions may not be played with the unit.
- The firmware of this unit is updated periodically. Be sure to update the firmware to the latest version before using the unit.

### USB memory device

- The unit supports the FAT16 and FAT 32 file system. It does not support the NTFS file system.
- The limit of folders and files that can be displayed on the unit is as shown below. (The limit shown includes the root folder.)









Folder layers	8
Folders	999
Files	999
File names, folder names	32
Artist names, song titles	60

- If there are too many characters to be displayed on one line, the display becomes scrollable.
- File names/title names/artist names/album names are displayed on the Media player display screen.

### NOTE

- Insert and remove a USB memory device with the power set to standby. If it is inserted or removed with the power on, the recorded files cannot be loaded or may be damaged.
- It is not compatible with an MP3 player, digital camera, a USB device for a mobile phone, etc.
- The unit cannot charge a USB device.
- The unit supports high-speed USB file transfer (conforming to USB 2.0).
- The unit does not support a card reader, USB extension cable, or USB hub.
- AVCHD content stored on the USB memory device connected to the unit can also be played.

## Files

Playable files (Extension)	Playable media			File specification	Symbols used in this Owner's Manual
	DVD-R/-RW/ +R/+RW CD-R/-RW	USB memory device	Network		
MP3 (.mp3)	○	○	○	<ul style="list-style-type: none"> <li>• Sampling frequency: 32 kHz, 44.1 kHz, 48 kHz</li> <li>• Bit rate: 64 kbps to 320 kbps</li> <li>• Audio type: MPEG1 audio layer 3</li> </ul>	
WMA * (.wma)	○	○	○	<ul style="list-style-type: none"> <li>• Sampling frequency: 32 kHz, 44.1 kHz, 48 kHz</li> <li>• Bit rate: 48 kbps to 192 kbps</li> <li>• Audio type: WMA ver. 9</li> </ul>	
AAC * (.m4a)	○	○	○	<ul style="list-style-type: none"> <li>• Sampling frequency: 32 kHz, 44.1 kHz, 48 kHz</li> <li>• Bit rate: 16 kbps to 320 kbps</li> <li>• Audio type: MPEG4, AAC</li> </ul>	
LPCM (.wav)	○	○	○	<ul style="list-style-type: none"> <li>• Sampling frequency: 44.1 kHz, 48 kHz</li> <li>• Number of bits: 16-bits</li> <li>• Number of channels: 2 channels</li> </ul>	
JPEG (.jpg/.jpeg)	○	○	○	<ul style="list-style-type: none"> <li>• Maximum resolution: 4,096 x 4,096 pixels</li> <li>• Minimum resolution: 32 x 32 pixels</li> <li>• Maximum file capacity: 12 MB</li> </ul>	
DivX® (.avi/.divx/.mkv)	○	○	○	<ul style="list-style-type: none"> <li>• Supporting version: up to DivX® PLUS HD (Except CD-R/-RW)</li> <li>• Maximum capacity: 2 GB</li> </ul>	
MPEG (.mpg/.mpeg /.mp4/.ts/.m2t)	×	○	○	<ul style="list-style-type: none"> <li>• Video: MPEG1, MPEG2, MPEG4</li> <li>• Audio: MP3, AAC, WMA, AC-3</li> </ul>	
WMV (.wmv)	×	○	○	<ul style="list-style-type: none"> <li>• Video: WMV9, WMV9AP (VC-1)</li> <li>• Audio: WMA, AAC, AC-3, DTS</li> </ul>	
AVI (.avi)	×	○	○	<ul style="list-style-type: none"> <li>• Video: MPEG1, MPEG2, MPEG4</li> <li>• Audio: PCM, MP3, AAC, AC-3</li> </ul>	

\* Files with digital rights management (DRM) other than those protected by DivX® and WMDRM of devices on the network cannot be played.



- Depending on recording conditions, these files may not be playable.
- If a file name/title name/artist name/album name includes characters that are not supported for the Media player display, it may not be displayed correctly.
- JPEG pictures recorded in the progressive system cannot be displayed.
- Variable Bit Rate (VBR) is not supported (when playback is possible, the time display in the display window will speed up and slow down).

### □ About DivX® Video-on-Demand (VOD)

- When you purchase or rent a DivX® file through the official site of DivX® Video-On-Demand (VOD) services, the unit registration code is required. For details, see "DivX Registration" (page 37).
- A DivX® VOD file recorded with a different code from the unit registration code cannot be played back.
- Some DivX® VOD files are restricted to a certain number of playable times. If your DivX® VOD file has such a limit, the number of playable times is displayed on the DivX® VOD display screen.
- Use ◀ ▶ to select "Yes" if you want to play a file, or to select "No" if you do not want to play it. Then, press **ENTER** to confirm the selection.

#### NOTE

- ABOUT DIVX PLUS™ HD: DivX® is a digital video format created by DivX, Inc. This is an official DivX Certified® device that plays DivX video, including DivX Plus™ HD video (H.264/.MKV) up to 1080p and premium content. Visit [www.divx.com](http://www.divx.com) for more information and software tools to convert your files into DivX video.
- ABOUT DIVX VIDEO-ON-DEMAND: This DivX Certified® device must be registered in order to play DivX Video-on-Demand (VOD) content. To generate the registration code, locate the DivX VOD section in the device setup menu. Go to [vod.divx.com](http://vod.divx.com) with this code to complete the registration process and learn more about DivX VOD.

□ About Discs and Files

**BD-Video, DVD-Video**

BD/DVD-Video discs are divided into several large sections (titles) and small sections (chapters). These sections are all allotted numbers, called title numbers and chapter numbers.

**[Example]**

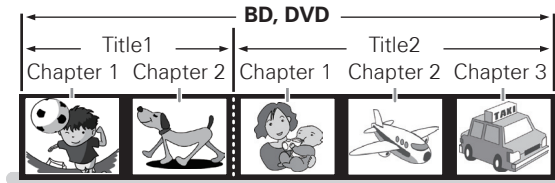

**Hybrid BD**

• Hybrid disc

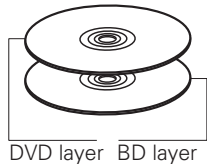

Two-layer Hybrid BD with an BD layer and a DVD layer. The signals on the DVD layer can be played on a regular DVD player.

**Super Audio CD**

**[Type of Super Audio CD]**

• Single layer disc

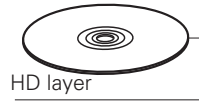

Single layer Super Audio CD with only an HD layer\*.

• Dual layer disc

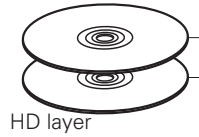

Super Audio CD with a double HD layer\*, offering extended playing time and high sound quality.

• Hybrid disc

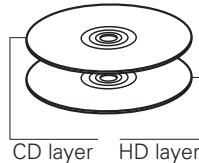

Two-layer Super Audio CD with an HD layer\* and a CD layer. The signals on the CD layer can be played on a regular CD player.

\* All Super Audio CD contain an HD (High Density) layer with high density Super Audio CD signals. This layer can contain a stereo channel area, a multi-channel area, or both a stereo channel and multi-channel area.

**DVD-Audio**

DVD-Audio discs are divided into several large sections (groups) and small sections (tracks). These sections are all allotted numbers, called group numbers and track numbers.

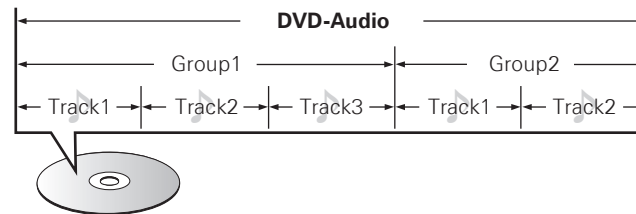

**CD**

CD is divided into several sections (tracks). These sections are all allotted numbers called track numbers.



**File**

Files, such as MP3/WMA/AAC/LPCM/JPEG/DivX®, recorded on DVD-R/-RW/+R/+RW, CD-R/-RW and USB memory device are divided into large segments (folders) and small segments (files). Files are stored in folders, and folders can be placed for storage in a hierarchy. The unit can recognize up to 8 levels of folders.

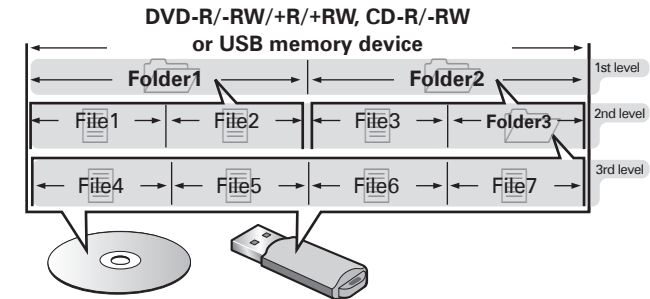

When writing MP3/WMA/AAC/JPEG/DivX® files on a CD-R/-RW disc, set the writing software's format to "ISO9660". The files may not play properly if they are recorded in other formats. For details, refer to the instructions of your writing software.

## Cautions on using media

### Inserting a disc

- Set the disc in the tray label side up.
- Make sure the disc tray is fully open when inserting the disc.
- Place the disc horizontally in the tray, aligned with the tray guide.



If a disc that cannot be played is loaded or the disc is loaded up-sidedown, "NO DISC" is displayed on the player's display.

#### NOTE

- Only load one disc at a time. Loading two or more discs can damage the unit or scratch the discs.
- Do not use cracked or warped discs or discs that have been repaired with adhesive, etc.
- Do not use discs on which the sticky part of cellophane tape or labels is exposed or on which there are traces of where labels have been removed. Such discs can get caught inside the player and damage it.
- Do not use discs in special shapes, as they may damage the player.



- Do not push the disc tray in by hand when the power is off. Doing so could damage the set.

### How to handle media

- Do not get fingerprints, oil or dirt on discs.
- Take special care not to scratch discs when removing them from their cases.
- Do not bend or heat discs.
- Do not enlarge the hole in the center.
- Do not write on the labeled (printed) surface with ball-point pens, pencils, etc., or stick new labels on discs.
- Condensation may form on discs if they are moved suddenly from a cold place (outdoors for example) to a warm place, but do not try to dry discs with a hairdryer, etc.
- Do not eject a USB memory device or turn off the unit while a USB memory device is being played. This may result in malfunction or loss of the USB memory device's data.
- Do not attempt to open or modify USB memory device.
- USB memory device and files can be damaged by static electricity. Do not touch the metal contacts of an USB memory device with your fingers.
- Do not use warped USB memory device.
- After use, be sure to remove any disc or USB memory device, and store it in its proper case, to avoid dust, scratches and deformation.
- Do not store discs in the following places:
  1. Places exposed to direct sunlight for long periods of time
  2. Dusty or humid places
  3. Places exposed to heat from heaters, etc.

### Cleaning discs

- If there are fingerprints or dirt on a disc, wipe them off before using the disc.
- Use a commercially available disc cleaning set or a soft cloth to clean discs.



Gently wipe the disc from the inside towards the outside.

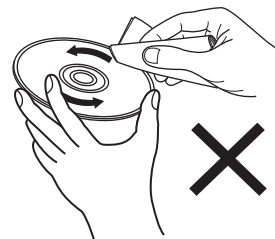

Do not wipe with a circular motion.

#### NOTE

Do not use record spray, antistatic agents, benzene, thinner or other solvents.

### About copyrights

- Unauthorised copying, broadcasting, public performance and lending of discs are prohibited.
- This item incorporates copy protection technology that is protected by U.S. patents and other intellectual property rights of Rovi Corporation. Reverse engineering and disassembly are prohibited.
- Portions of this product are protected under copyright law and provided under license by ARIS/SOLANA/4C.

# Other information

## About digital signal audio output

The unit can convert the format of digital audio signals recorded on media and output them. Make settings for a digital audio signal depending on the specifications of the connected device.

- Audio signal input may not be supported depending on the HDMI compatible monitor (projector, etc.) being used.

When the unit is connected to this kind of device, audio signals are not output from the HDMI terminal.

Media/Files	Audio format	Analog Audio Output Terminal	Digital Audio Output Terminal (Coaxial)		HDMI Output Terminal (*1,*2,*4)	
		MIX 2channel	Bit-stream (*2) (Default setting)	PCM	Bit-stream (*2) (Default setting)	PCM
BD	DOLBY DIGITAL	2ch Linear PCM	DOLBY DIGITAL	2ch Linear PCM	DOLBY DIGITAL	Multi Linear PCM (*3)
	DOLBY DIGITAL PLUS				DOLBY DIGITAL PLUS	
	DOLBY TrueHD				DOLBY TrueHD	
	DTS				DTS Digital Surround	
	DTS-HD				DTS-HD	
Linear PCM	2ch Linear PCM					
BD-R/-RE	DOLBY DIGITAL		DOLBY DIGITAL			
	MPEG-2 AAC		MPEG-2 AAC (*7)			
	Linear PCM		2ch Linear PCM			
AVCHD	DOLBY DIGITAL		DOLBY DIGITAL			
	2ch Linear PCM		2ch Linear PCM			
DVD-Video	DOLBY DIGITAL		DOLBY DIGITAL			
	DTS Digital Surround		DTS Digital Surround			
	Linear PCM		2ch Linear PCM			
DVD-Audio	Linear PCM / P.PCM		2ch Linear PCM			
DivX® (*8)	DOLBY DIGITAL		DOLBY DIGITAL			
	MP3, MP2		2ch Linear PCM			
Super Audio CD	Multi area		No audio output		DSD (*5)	
	Stereo area	2ch Linear PCM				
	CD layer					
CD, MP3, WMA		2ch Linear PCM				
AAC			AAC (*6)			
DTS-CD		DTS Digital Surround	2ch Linear PCM	DTS Digital Surround	Multi Linear PCM	

\*1 : The output format is automatically changed depending on the audio format or number of channels that the connected HDMI device supports.

\*2 : If "BD audio mode" is set to "MIX Audio Output", secondary audio and interactive audio are mixed and output (see page 6, 24).

\*3 : Contents of DTS-HD MA 5.1ch/192 kHz are output as 5.1ch/96 kHz.

\*4 : If the connected HDMI device does not support Dolby Digital Plus, Dolby TrueHD, or DTS-HD, the signal is output as Dolby digital or DTS Digital Surround bit stream. If it does not support the Dolby Digital or DTS Digital Surround bit stream, it is output as multi-linear PCM or 2-channel linear PCM.

\*5 : If the connected HDMI device does not support DSD, the signal is output as Linear PCM.

If a DSD signal is output from the HDMI output terminal, the signal output from the analog audio output terminals is muted.

\*6 : If the connected HDMI device does not support AAC, the signal is output as Linear PCM.

\*7 : If the connected HDMI device does not support AAC, the signal is not output.

\*8 : If the connected HDMI device does not support HE-AAC, the signal is not output.

About digital signal audio output

**Copyright protection system (HDCP)**









In order to play back digital video and audio such as BD-Video or DVD-Video via HDMI connection, both the player and TV or the AV receiver need to support the copyright protection system known as HDCP (High-bandwidth Digital Content Protection System). HDCP is copyright protection technology comprising data encryption and authentication of the connected AV device. Our this unit supports HDCP.

**NOTE**

If a device that does not support HDCP is connected, video and audio are not output correctly. Read the owner's manual of your television or AV receiver for more information.

**Trademark information**

This product uses the following technologies:

	"Blu-ray Disc™" and  logo are trademarks of Blu-ray Disc Association.
	"Blu-ray 3D™" and Blu-ray 3D™ logo are trademarks of Blu-ray Disc Association.
	The "BD-LIVE" logo is a trademark of Blu-ray Disc Association.
BONUS VIEW™	"BONUSVIEW" is the trademark of Blu-ray Disc Association.
	 is a trademark of the DVD Format / Logo licensing Corporation.
<b>HDMI</b>	HDMI, the HDMI Logo and High-Definition Multimedia Interface are trademarks or registered trademarks of HDMI Licensing LLC in the United States and other countries.
	Java and all other trademarks and logos are trademarks or registered trademarks of Sun Microsystems, Inc. in the United States and/or other countries.
	Manufactured under license from Dolby Laboratories. Dolby and the double-D symbol are trademarks of Dolby Laboratories.
	Manufactured under license under U.S. Patent #'s: 5,451,942; 5,956,674; 5,974,380; 5,978,762; 6,226,616; 6,487,535; 7,392,195; 7,272,567; 7,333,929; 7,212,872 & other U.S. and worldwide patents issued & pending. DTS and the Symbol are registered trademarks, & DTS-HD, DTS-HD Master Audio   Essential and the DTS logos are trademarks of DTS, Inc. Product includes software. © DTS, Inc. All Rights Reserved.

	Windows Media and the Windows logo are trademarks or registered trademarks of Microsoft Corporation in the United States and/or other countries.
	DivX®, DivX Certified®, DivX Plus™ HD and associated logos are registered trademarks of DivX, Inc. and are used under license.
<b>AVCHD</b>	"AVCHD" and the "AVCHD" logo are trademarks of Panasonic Corporation and Sony Corporation.
<b>x.v.Color</b>	"x.v.Color" and the "x.v.Color" logo are trademarks of Sony Corporation.
	 is the trademark of Eastman Kodak Company.
	DLNA®, the DLNA Logo and DLNA CERTIFIED® are trademarks, service marks, or certification marks of the Digital Living Network Alliance. Device Class: DMP (Digital Media Player) DLNA Certified® Product Function: FINDS, PLAYS Content Type: audio, images, videos (Check supported media formats.) DLNA consumer website: <a href="http://www.dlna.org">www.dlna.org</a> Some content may not be compatible with other DLNA Certified® products (example: optional media formats).
	YouTube and the YouTube logo are the registered trademarks of Google Inc.
	Netflix and Netflix logo are the registered trademarks of Netflix, Inc.

# Explanation of Terms

## Numerics

### 4:3 letterbox

When a wide (16:9) disc is played on the unit while connected to a 4:3 TV, this function displays the image with a black area at the top and bottom.

### 4:3 pan-and-scan

When a wide (16 : 9) disc is played on the unit while connected to a 4:3 TV, this function cuts the left and right of the displayed image to the 4 : 3 size according to the disc's control information.

## A

### AAC (Advanced Audio Coding)

This is an internationally standardized audio data compression scheme. It has a compression ratio 1.4 times higher than the "MP3 audio compression scheme adopted for "MPEG-1.

### Aspect ratio

This is the length and width ratio of the TV screen. The conventional TV screen's ratio is 4:3 and a wide screen TV's screen ratio is 16:9.

### Audio commentary

This is an audio program included as a bonus feature in a DVD-Video or BD-Video. It uses a multi-audio function to provide an audio explanation or commentary by members of the crew or director, etc. to accompany the video.

## B

### BD-J (Java)

BD-Video offer fun software with more interactive functions (games) that use Java applications.

### BD-LIVE

The unit can be connected to the Internet to enjoy a number of features, including additional contents such as special video or subtitles, network games, etc.

### Bit rate

This is the amount of video or audio data recorded on a disc that is read in one second.

### Blu-ray disc

This is a one-sided, one-layer disc with 25 GB capacity for recording high vision video movie and games.

### Bonus View

Special images for BD-Video. It includes comments from the movie director, simultaneously developing sub-stories, and images from different angles.

## C

### Chapter

This is a break intended by the producer, who organizes the titles of BD or DVD-Video. The chapter search function searches for the beginning of this break.

## D

### Deep Color

This technology allows expression of more colors than the conventional 8-bit and can reproduce more natural colors without any color streaking.

### Default Gateway

This device is the entry and exit point between an internal network and an external network (Internet, etc.).

### DHCP (Dynamic Host Configuration Protocol)

This function assigns IP addresses automatically to network devices.

### DivX

This is a video codec (video compression/decompression software) developed by DivX, Inc.

The compression technology is based on "MPEG-4 Part 2" (known as "MPEG-4 ASP"). It allows along video to be compressed into a small file while maintaining a high-quality image.

It is available in the free "DivX" version or the paid "DivX PRO" version.

### DLNA

An abbreviation of Digital Living Network Alliance.

An industry group that was established to decide specifications for the mutual connection of audio visual devices and computers in a home network and the mutual utilization of music, photo and video data.

This unit is based on DLNA Home Networked Device Interoperability Guidelines.

### DNS (Domain Name System)

A system that matches host names on the Internet to IP addresses.

### Dolby Digital (5.1-ch Surround)

This is a stereophonic effect developed by Dolby Laboratories. This is a maximum of 5.1 channels, independent multi-channel audio system.

### Dolby Digital Plus

This is an extended version of Dolby Digital and is a high sound quality, digital audio technology adopted as an optional audio for Blu-ray discs.

### Dolby TrueHD

This lossless coding technology is adopted as an optional audio for Blu-ray disc and supports 7.1 channels.

### Downmix

This function converts the number of channels of surround audio to less channels for playback.

### DTS

This is an abbreviation of Digital Theater System, which is a digital audio system developed by DTS. When playing audio on this system while connected to a device such as a DTS amplifier, accurate sound field position and realistic sound effects can be obtained, making you feel like you are in a movie theater.

### DTS-HD

This audio technology provides an enhanced functionality and a higher quality of sound than conventional DTS and is adopted as an optional audio for Blu-ray disc. This technology supports multi-channel, high data transfer speed, high sampling-frequency, and lossless audio playback. A maximum of 7.1 channels are supported on Blu-ray discs.

### Dynamic range

The difference between the maximum, undistorted sound level and the minimum sound level that is discernible above the noise emitted by the device.

## F

### Finalizing

This process enables BD/DVD/CD recorded with a recorder to be played by other players.

## H

### HDCP

When transmitting digital signals between devices, this copyright protection technology encrypts the signals to prevent content from being copied without authorization.

### HDMI

This is an abbreviation of High-Definition Multimedia Interface, which is an AV digital interface that can be connected to a TV or amplifier. Video signal and audio signal can be connected with 1 cable.

## I

### Interlacing (interlaced scanning)

This conventional method used to project images on a TV displays 1 frame of image in half and half, respectively as 2 fields.

### Interactive audio

This is audio recorded in the titles of BD-Video, such as clicking sounds made during operations.

### IP Address

An identification number that is assigned to each network device.

## J

### JPEG (Joint Photo graphic Experts Group)

This is a still picture data compression standard. Its ability to reduce the size of a file with relatively little deterioration in image quality means that it is widely used for storing images in video cameras, etc.

## L

### LAN (Local Area Network)

A wired or wireless network that connects devices together.

### LFE

This is an abbreviation of Low Frequency Effect, which is an output channel that emphasizes low-frequency effect sounds. Surround audio is intensified by outputting 20 Hz to 120 Hz deep bass.

### Linear PCM

This is an uncompressed PCM (Pulse Code Modulation) signal. This is the same system as the CD audio but uses 192 kHz, 96 kHz, and 48 kHz sampling frequencies on BD or DVD and provides higher sound quality than CD.

## M

**MAC Address**

A unique identification number for network devices such as LAN cards.

**MP3 (MPEG AudioPlayer 3)**

This is an internationally standardized audio data compression scheme, using the "MPEG-1" video compression standard. It compresses the data volume to about one eleventh its original size while maintaining sound quality equivalent to a music CD.

**MPEG**

This is an abbreviation of Moving Picture Experts Group, which is an international standard of the moving picture audio compression method. Images on BD and DVD are recorded using this method.

## N

**Netflix**

This is a video streaming distribution service offered by Netflix Inc. in the United States.

## P

**Picture-in-picture**

This BD-Video function allows you to view scenes, such as the making of or commentary on the movie, in the secondary video while viewing the main story in the primary video.

**Pop up menu**

This type of menu is recorded with BD software. While playing back a BD, this menu can be displayed on the front of the screen and can be operated.

**Primary audio**

This audio signal is recorded in the main story in BD-Video.

**Primary subtitle**

This subtitle is recorded in the main story in BD-Video.

**Primary video**

This video signal is recorded in the main story in BD-Video.

**Progressive (sequential scanning)**

This is a system for scanning the video signal that displays 1 frame of video as one image. Compared to the interlace system, this system provides images with less flickering and bleeding.

**Proxy**

This is a hookup to secure high-speed access and safe transmission for connecting to the Internet from the internal network.

## R

**Rating**

Depending on the age of the viewer, this function restricts the playing of BD-Video or DVD-Video. The unit can be set to restrict viewing in 0 to 254 levels for BD-Video, and 1 to 8 levels for DVD-Video.

**Region code**

This code indicates the country or region where the BD or DVD-Video can be played back.

## S

**Sampling frequency**

Sampling involves taking a reading of a sound wave (analog signal) at regular intervals and expressing the height of the wave at each reading in digitized format (producing a digital signal).

The number of readings taken in one second is called the "sampling frequency". The larger the value, the closer the reproduced sound is to the original.

**Secondary audio**

This is audio content, such as the director's comments, and other data recorded in the bonus view of BD-Video.

**Secondary subtitle**

This subtitle, such as the director's comments and other data recorded in the bonus view of BD-Video.

**Subnet Mask**

A 32-bit value that defines which bits in an IP address are reserved for a network address for identifying the network.

## T

**Title**

This is the unit of content that consists of chapters of BD or DVD-Video. Some BD or DVD-Video may include multiple titles.

## W

**WMA (Windows Media Audio)**

This is audio compression technology developed by Microsoft Corporation.

WMA data can be encoded using Windows Media® Player Ver.7, 7.1, Windows Media® Player for Windows® XP and Windows Media® Player 9 Series.

To encode WMA files, only use applications authorized by Microsoft Corporation. If you use an unauthorized application, the file may not work properly.

## X

**x.v.Color**

This function lets HDTVs display colors more accurately. It enables display with natural, vivid colors. "x.v.Color" is a Sony registered trademark.

## Y

**YouTube**

This is the video-content sharing site managed by YouTube Inc.



# Troubleshooting

If a problem occurs, firstly check the following:

1. Are the connections correct?

2. Is the set being operated as described in the owner's manual?

3. Are other components operating properly?

If this unit does not operate properly, check the items listed in the table below. If the problem continues there may be a malfunction.

In this case, disconnect the power immediately and contact your retail outlet.

## [General]

Symptom	Cause/Solution	Page
Power does not turn on.	• Check if the power cord is properly connected.	5
	• Plug the power supply cord into the power outlet.	5
	• The safety protection device may be activated. Unplug the power cord once, and wait for 5-10 seconds and then plug it in again.	5
Playback does not start even when ► is pressed, or starts but stops immediately.	• Is there condensation inside the player or on the disc? (Let it sit for 1 to 2 hours with the power off.)	2
	• When the disc is scratched or contaminated with fingerprints, the disc may not play correctly. Clean the disc or replace with a non-scratched disc.	48
	• Is the disc loaded upside-down? Load the disc properly, with the side to be played face down.	6
	• Is an unplayable disc loaded?	45
No return to start-up screen when a disc is removed.	• No disc is inserted. Insert a disc.	6
	• There may be an internal error. Set the power to standby, wait awhile, then turn the power back on.	5
Buttons do not work or the unit stops responding.	• Operations may not be permitted by the disc.	13
	• The safety protection device may be activated. Unplug the power cord once, and wait for 5-10 seconds and then plug it in again.	5
	• Refer to the instructions of the disc.	-
The camera angle does not switch.	• If the multiple angles are not recorded in a BD-Video or DVD-Video, the camera angle cannot be switched. Also, multiple angles may only be recorded for specific scenes.	20
Playback does not start when a title is selected.	• Playback may be prohibited by the viewing restriction setting. Check the "Ratings" setting on the GUI menu.	35
I have forgotten the password for the rating level.	• On the GUI menu, perform the "System" – "Initialize" procedure.	34

## [Video]

Symptom	Cause/Solution	Page
No picture appears.	• Switch the TV's input setting to the external input connected to the player.	5
	• Is the Pure Direct function set to "Pure Direct 1" or "Pure Direct 2"? Set it to "Off".	21
	• Check the connection of the video/component video cable.	9, 10
	• Is it set to "24p Output On" by pressing <b>HDMI MODE</b> on the remote control? If so, no video signals are output from the video and component video terminals during playback of certain discs.	22
	• Does the setting of resolution on the match the connected device's resolution?	22
	• Is the resolution is set according to the connected device by pressing <b>RESOLUTION</b> on the remote control? Make settings for resolution.	22
	• The video cable is not connected securely. Connecte the video cable securely.	9 – 11
The picture is not displayed or is disrupted. The picture of a BD-Video or DVD-Video disc is in black and white.	• The HDMI OUT connector is probably connected to a DVI IN connector of equipment. DVI connection does not support HDCP and the video is not output correctly.	11, 50
	• The picture may be slightly disturbed right after fast-forwarding or reversing. This is not a malfunction.	17
The picture freezes momentarily during playback.	• Connect the unit's video/component video output either directly to the TV or to the TV via the AV receiver. Do not connect via a VCR, (video cassette recorder). Some discs include copy prohibit signals, and when such discs are played via a VCR the copy guard system may disrupt the picture.	11
	• Is a disc that is not compatible with the player or a disc with a different region number loaded? (This player supports region code "A" for BD-Video discs, "1" or "ALL" for DVD-Video discs.)	45
Subtitles are not displayed.	• If a disc is scratched or contaminated with fingerprints, the disc may not play correctly. Clean the disc or replace with a non-scratched disc.	48
	• There may be a problem with the data recorded on the disc.	45
Subtitles are not displayed.	• Subtitles cannot be displayed for BD-Video, DVD-Video or DivX® files that do not contain subtitles.	20
	• Is the subtitle setting "Off"? Use the disc menu or <b>SUBTITLE</b> to set the subtitles to display.	20

[Audio]

Symptom	Cause/Solution	Page
HD audio is not output.	<ul style="list-style-type: none"> <li>Set "BD Audio Mode" to "HD Audio Output".</li> </ul>	6, 24
No sound or the sound is hard to hear.	<ul style="list-style-type: none"> <li>Check the audio connections of connected devices and speakers.</li> <li>Is the power connected audio devices turned on?</li> <li>Is the input selection set to the input to which the unit is connected?</li> <li>Is the audio output properly selected?</li> </ul>	9 – 12 – 6, 19, 49
No sound.	<ul style="list-style-type: none"> <li>The unit is in reverse play, fast forward, fast reverse, slow forward, slow reverse or pause mode. Return to the normal playback.</li> <li>The HDMI OUT connector is probably connected to a DVI IN connector of equipment. DVI connection does not support HDCP and the audio is not output correctly.</li> <li>Is the Pure Direct function set to "Pure Direct 1" or "Pure direct 2"? Set it to "Off".</li> </ul>	19 11, 50 21
Interactive audio is not output.	<ul style="list-style-type: none"> <li>Set "BD Audio mode" to "Mix Audio Output" using the Mode setting menu.</li> </ul>	6, 24
Multi-channel audio is not output.	<ul style="list-style-type: none"> <li>Is the multi-channel audio selected? Press <b>AUDIO</b> of the remote control to switch from audio supported by a disc to multi-channel audio.</li> </ul>	19
The 192 kHz digital audio is not output from the DIGITAL OUT COAXIAL connector.	<ul style="list-style-type: none"> <li>"Audio Output" – "Down Sampling" on the GUI menu is not set to 192 kHz. Set "Down Sampling" to 192 kHz.</li> <li>The content stored in a disc to be played back is copyright protected. Even if "Down Sampling" is set to 192 kHz, the audio signal is output using 48 kHz.</li> </ul>	38 38

[HDMI]

Symptom	Cause/Solution	Page
Video and audio are not output via the HDMI connection.	<ul style="list-style-type: none"> <li>Check the connection of the HDMI cable.</li> </ul>	4
	<ul style="list-style-type: none"> <li>Is the "HDMI" indicator on the display of the unit lit?</li> </ul>	21
	<ul style="list-style-type: none"> <li>Is the Pure Direct function set to "Pure Direct 1" or "Pure Direct 2"? Set it to "Off".</li> </ul>	21
	<ul style="list-style-type: none"> <li>Check whether the connected display device or other device supports HDCP. This unit will not output a video signal unless the other device supports HDCP. See the owner's manual of your TV, AV receiver, etc.</li> <li>Check that the setting of the HDMI video resolution supports the resolution of the connected device. When set to "Auto", this unit makes the setting automatically.</li> </ul>	50 22
Video and audio are not output via the HDMI connection.	<ul style="list-style-type: none"> <li>Turn off power of the unit and then turn it back on.</li> </ul>	4, 5
	<ul style="list-style-type: none"> <li>Turn off power of the connected device and then turn it back on.</li> </ul>	4, 5
	<ul style="list-style-type: none"> <li>Unplug the HDMI cable and then plug it in again.</li> </ul>	4, 5
	<ul style="list-style-type: none"> <li>When you connect the unit to an AV receiver, first connect the unit directly to a television and check the video and audio output. If output is performed properly, connect the unit to the AV receiver again and check the AV receiver setting.</li> </ul>	–

[USB memory device]

Symptom	Cause/Solution	Page
My USB memory device cannot be read.	<ul style="list-style-type: none"> <li>The format of the USB memory device does not match this unit or the USB memory device is not compatible.</li> <li>Is the playback media mode set to "USB MODE"? Select "USB" with <b>SOURCE</b>.</li> </ul>	34 28, 29
	<ul style="list-style-type: none"> <li>Has the unit initialized the USB memory device with applicable formats? (FAT16/FAT32)</li> <li>Are you using a USB hub? If so, directly connect the USB memory device to a USB port on the front panel of the unit.</li> <li>Are you using a USB extension cable? If so, directly connect the USB memory device to the USB port on the front panel of the unit.</li> <li>Are the USB memory device contents applicable to this unit? Use the "Files" menu to confirm whether the contents are applicable to the unit.</li> <li>When a USB memory device of 192 MB or less is formatted with FAT32, this unit may not be able to read it. If that is the case, format it with FAT16.</li> <li>This unit does not support a USB memory device containing encrypted data.</li> </ul>	26, 34 26 26, 45 46 26, 45 –
The USB memory device is not recognized.	<ul style="list-style-type: none"> <li>Some USB memory devices cannot be operated by the power supplied from this unit. The unit supplies 5 V/1 A to a USB memory device. Use a USB memory device that is compatible with the specifications of this unit.</li> <li>Check if the USB memory device is firmly connected to the USB port.</li> </ul>	– 26
Files that begin with "." cannot be played.	<ul style="list-style-type: none"> <li>When content created by Mac OS X is copied into a USB memory device, all contents as well as hidden files are copied. Although the extension of this file is the same as the extension of the content, it is actually not the content. Delete this file using another OS such as Windows.</li> </ul>	–
Unable to play back BD-LIVE / bonus view.	<ul style="list-style-type: none"> <li>Does the USB memory device have more than 1 GB of available space?</li> </ul>	15
	<ul style="list-style-type: none"> <li>Has the USB memory device been initialized by the unit?</li> </ul>	34
	<ul style="list-style-type: none"> <li>Was the USB memory device inserted while the power of the unit was on? (Insert the USB memory device while the unit is in the standby status.)</li> </ul>	26

**[Disc]**

Symptom	Cause/Solution	Page
A playable disc is not read.	<ul style="list-style-type: none"> <li>The pickup lens may be dirty. Before requesting servicing, try cleaning the laser pickup with a commercially available lens cleaner. (Do not use a cleaner with a brush because it may damage the lens.)</li> </ul>	-
A disc cannot be played back.	<ul style="list-style-type: none"> <li>The finalizing procedure after recording has not been performed correctly. Finalize a disc properly.</li> </ul>	45

**[Network]**

Symptom	Cause/Solution	Page
Cannot connect to the network.	<ul style="list-style-type: none"> <li>The LAN cable is not connected. Correct the network connections.</li> </ul>	27
	<ul style="list-style-type: none"> <li>The IP address is incorrect. Correct the network settings.</li> </ul>	36
	<ul style="list-style-type: none"> <li>The connection has been blocked by the firewall. Allow communication with the unit.</li> </ul>	27
Can not find the server	<ul style="list-style-type: none"> <li>The server is not running. Start the server.</li> </ul>	29
	<ul style="list-style-type: none"> <li>The server has not authenticated the unit. Authenticate the unit on the server side.</li> </ul>	27
	<ul style="list-style-type: none"> <li>The unit does not recognize the server. Obtain the server list again.</li> </ul>	29
The media player does not respond.	<ul style="list-style-type: none"> <li>There is a large number of files in the list and processing takes time. Wait until the process finishes.</li> </ul>	46
	<ul style="list-style-type: none"> <li>Multiple servers are starting or updating information. Wait until the process finishes.</li> </ul>	-
	<ul style="list-style-type: none"> <li>The media player no longer responds to operations. Press dlna search on the media player menu.</li> </ul>	29
Cannot obtain the file list.	<ul style="list-style-type: none"> <li>The server is creating the file list. It may take some time for the server to create the file list. If that is the case, wait until the list creation has finished.</li> </ul>	-
	<ul style="list-style-type: none"> <li>The number of files that can be registered by the server has been exceeded. Limit the number of files formats to the range that can be registered by the server. For details, see the server's user guide.</li> </ul>	-
	<ul style="list-style-type: none"> <li>Characters that are not supported by the server are used in areas such as the file name. Limit the number of files formats to the range that can be registered by the server. For details, see the server's user guide.</li> </ul>	-
Can not play DRM-protected files.	<ul style="list-style-type: none"> <li>The server does not support DRM. Connected to a server that does support DRM.</li> </ul>	46
	<ul style="list-style-type: none"> <li>The server has not obtained the DRM license. Obtain the DRM license on the server side in advance.</li> </ul>	46
Takes time to play or change to the next file.	<ul style="list-style-type: none"> <li>The file size is large. This is not a malfunction.</li> </ul>	46
	<ul style="list-style-type: none"> <li>DRM-protected content is being played. This is not a malfunction.</li> </ul>	46
Takes time for the file list to display.	<ul style="list-style-type: none"> <li>There is a large number of files in the list. During random play, the larger the number of files in the server, the longer it takes to display the file list. Reduce the number of connected servers or reduce the number of files registered on the server.</li> </ul>	-

Symptom	Cause/Solution	Page
Cannot play even though the file format is supported for playback.	<ul style="list-style-type: none"> <li>The server does not support this file format. Only files whose formats are supported by both the unit and the server can be played. See the server's user guide.</li> </ul>	46
	<ul style="list-style-type: none"> <li>There is not enough network bandwidth. Communication in a network may become congested, Stop the communication of the other devices, or redesign your network environment.</li> </ul>	27, 31
Playback breaks up.	<ul style="list-style-type: none"> <li>The file bit rate is too high. Communication in a network may become congested, Stop the communication of the other devices, or redesign your network environment.</li> </ul>	46

**[BD-Live]**

Symptom	Cause/Solution	Page
BD-Live function does not work.	<ul style="list-style-type: none"> <li>Network connection is not established. Perform the connection test. If "Network is FAILED." is displayed in the test, check the network cable connection and settings.</li> </ul>	36
	<ul style="list-style-type: none"> <li>When the BD-LIVE™ function is used, the line speed of the broadband being used is not sufficient. Consult with the Internet Service Provider (ISP) and change it to the speed recommended for using a broadband line.</li> </ul>	15
	<ul style="list-style-type: none"> <li>Check if the disc has support for BD-LIVE™.</li> </ul>	-
	<ul style="list-style-type: none"> <li>If the BD-LIVE™ function does not work even after data is downloaded into a USB memory device, reformat the USB memory device on this unit.</li> </ul>	34
Cannot play BD-LIVE™ video.	<ul style="list-style-type: none"> <li>The "BD-LIVE Connection" setting of "Network" menu is set to "Prohibited". Set it to "Permitted".</li> </ul>	36
	<ul style="list-style-type: none"> <li>The content downloaded to the built-in memory or USB memory device are provided as a part of the BD-Video content by the video company who recorded the disc. You cannot copy BD-LIVE™ video or audio content into a USB memory device and play that USB memory device independently on equipment other than this unit.</li> </ul>	15

Simple version

Basic version

Advanced version

Information

[Netflix/YouTube]

Symptom	Cause/Solution	Page
Playback stops from time to time during playback of the video streaming distribution service	<ul style="list-style-type: none"> <li>When Netflix or YouTube function is used, the line speed of the broadband being used is not sufficient. Consult with the Internet Service Provider (ISP) and change it to the speed recommended for using a broadband line.</li> </ul>	31

[Remote control]

Symptom	Cause/Solution	Page
The set cannot be operated with the remote control.	<ul style="list-style-type: none"> <li>Aim the remote control directly at the infrared sensor window on the front of the unit.</li> </ul>	44
	<ul style="list-style-type: none"> <li>Operate within a distance of 23 feet / 7 m from the remote control sensor.</li> </ul>	44
	<ul style="list-style-type: none"> <li>Remove any obstacles.</li> </ul>	44
	<ul style="list-style-type: none"> <li>Replace the batteries with new ones.</li> </ul>	44
	<ul style="list-style-type: none"> <li>Insert the batteries in the proper direction, checking the ⊕ and ⊖ marks.</li> </ul>	44
	<ul style="list-style-type: none"> <li>Match the signal code of the remote control to the signal code of the unit.</li> </ul>	44
The unit is operated by the remote control of an other DENON product.	<ul style="list-style-type: none"> <li>The unit is designed to be operated by the remote controls of other DENON products.</li> </ul>	44
	<ul style="list-style-type: none"> <li>To avoid the unit being operated by the remote controls of other devices, set "Others" – "Receive Legacy Remocon" to "Off" on the GUI menu.</li> </ul>	44



- Some functions may not be used under certain operating conditions, but this is not failure of the unit. Read the description in this Owner's Manual for details on correct operations.
- The volume may differ from disc to disc. This is due to the differences in how the signals are recorded on the disc and is not a malfunction.
- During programmed playback, it is not possible to perform random playback or to start playback from a desired track or file.
- Some functions are prohibited on some discs.

# Specifications

## Audio performance

**Signal format :**

NTSC, PAL

**Applicable discs /memory device :**

- (1) BD-Video disc :
  - 12 cm, 1 side, 1 layer; 12 cm, 1 side, 2 layers
- (2) DVD-Video / DVD-Audio disc :
  - 12 cm, 1 side, 1 layer; 12 cm, 1 side, 2 layers / 12 cm, 2 sides, 2 layers (1 side, 1 layer)
  - 8 cm, 1 side, 1 layer; 8 cm, 1 side, 2 layers / 8 cm, 2 sides, 2 layers (1 side, 1 layer)
- (3) Super Audio CD :

12 cm, 1 layer / 12 cm, 2 layer / 12 cm, Hybrid

(4) Compact Disc (CD-DA) :

12 cm / 8 cm disc

(5) Memory device :

USB memory device

**Video output :**

Output level : 1 Vp-p (75 Ω)

Output terminal : Pin-jack, 1 set

**Component video output :**

Y output level : 1 Vp-p (75 Ω)

Pb/Cb output level / Pr/Cr output level : 0.648 Vp-p (75 Ω)

Output terminal : Pin-jack, 1 set

**HDMI output :**

Output terminal : 19-pin HDMI terminals, 1 set

HDMI ver. 1.4a

(Deep Colour, Dolby Digital Plus, Dolby TrueHD, DTS-HD, 3D)

**Analog audio output :**

Output level : 2 Vrms (10 kΩ)

2 channels output terminal : Pin-jack, 1 set

**Audio output characteristics :**

(1) Frequency response

- ① BD (Linear PCM) : 2 Hz - 22 kHz (48 kHz sampling)
- : 2 Hz - 44 kHz (96 kHz sampling)
- : 2 Hz - 88 kHz (192 kHz sampling)
- ② DVD (Linear PCM) : 2 Hz - 22 kHz (48 kHz sampling)
- : 2 Hz - 44 kHz (96 kHz sampling)
- : 2 Hz - 88 kHz (192 kHz sampling)
- ③ Super Audio CD : 2 Hz - 40 kHz
- ④ CD : 2 Hz - 20 kHz

(2) S/N ratio : 115 dB

(3) Total harmonic distortion : 1 kHz, 0.0025 % (BD)

(4) Dynamic range : 100 dB (BD)

**Digital audio output :**

Coaxial digital output: Pin-jack, 1 set

## General

**Power supply :**

AC 120 V, 60 Hz

**Power consumption :**

25 W

 page 34 "Power Saving")

- When in Power Saving Standby : 0.3 W

- When in Normal Standby : 0.5 W

**Maximum external dimensions :**

434 (W) x 107 (H) x 319 (D) mm (17-1/8" x 4-1/4" x 12-9/16")

**Weight :**

4.2 kg (9.3 lbs)

## Remote control (RC-1151)

**Remote control type :**

Infrared pulse

**Batteries :**

R6/AA Type (two batteries)

**Maximum external dimensions :**

53 (W) x 28 (H) x 224 (D) mm (2-3/32" x 1-7/64" x 8-13/16")

**Weight :**

155 g (5.5 oz, including batteries)

\* For purposes of improvement, specifications and design are subject to change without notice.

## Index

 Numerics

3D	
3D Output Setting	38
TV Screen Size Setting	38
4:3 LB (letter box)	37, 51
4:3 PS (pan-and-scan)	37, 51

 A

AAC	46, 51
Accessories	1
Adjusting the picture quality	23
Aspect ratio	37, 51
Audio commentary	14, 51
Audio format	49
Audio Output	
Coaxial	38
Down Sampling	39
DRC	39
HDMI	38
Audio Setting	38
AVCHD	45, 49

 B

BD	47, 49
BD-J (Blu-ray Disc Java)	17, 51
BD-LIVE	15, 51
BD-Video	45, 47
Bit rate	46, 51
Blu-ray Disc	14, 45, 51
Bonus View	14, 51

 C

Cable	
Audio and video cable	9, 10, 11, 12, 26
Coaxial digital cable	10, 12
Component video cable	9, 10, 11, 26
Ethernet cable	27
HDMI cable	4, 11, 26
Power cord	5
CD	45, 47
CD-R/RW	45, 47
Chapter	47, 51
Connection	
2-channel audio amplifier	12
AV receiver	9
Digital recording device	12
HDMI	4
Network	26
Power cord	5
TV	11
USB memory device	26

 D

Deep Color	51
Default Gateway	36, 51
DHCP	36, 51
Dimmer control	21
Disc menu	7, 14
DISC MODE	29
Display	41
DivX	46, 51
DLNA	27, 28, 51
DNS	36, 51
Dolby Digital	49, 51
Dolby Digital Plus	49, 51
Dolby TrueHD	49, 51
Downmix	41, 51
DTS	49, 51
DTS-HD	49, 51
DVD-Audio	45, 47
DVD-R/RW/+R/+RW	45, 47
DVD-Video	45, 47
DVI-D connector	11
Dynamic Range	39, 51

 F

File	46, 47
Finalizing	45, 51
Folder	47
Front panel	41

 G

General Setting	34
Group	47
GUI menu operation	33

 H

HDCP	50, 51
HD Layer	15, 47
HDMI	4, 22, 37, 51
Color Space	37
HDMI Deep Color	37
HDMI control	21
HDMI output settings	22
HOME menu screen	28
MEDIA PLAYER	28
NETFLIX	31
Setup	32
YouTube	31

 I

Information bar display	13
Interactive audio	6, 24, 51
Interlacing	51
IP Address	36, 51

 J

JPEG	46, 51
------	--------

 L

LAN	27, 51
Language	
Dialog	35
Disc Menus	35
GUI Language	35
Subtitle	35
LFE	51
Linear PCM(LPCM)	49, 51

 M

MAC Address	39, 52
Marker function	18
Media player display	13
Menu map	32
Mode setting	24
BD Audio Mode	24
Secondary Audio	24
Secondary Subtitle	24
Secondary Video	24
Subtitle Style	24
MP3	46, 49, 52
MPEG	46, 52
Multi linear PCM	49

 N

Netflix	52
Network	
BD-LIVE Connection	36
Connection Test	36
DHCP	36
Information	36
Internet Connection	36
Proxy Setting	36

 O

Operation	
A-B repeat	19
Angle	20
Chapter/track/ file	17
Fast-forward/fast-reverse	17
Frame by frame	19
Maker function	18
Pausing	17
Primary audio	19
Primary subtitle	20
Program	20
Random	20
Repeat	19
Search mode	18
Slow-forward/slow-reverse	19
Stopping	17
Others	
Angle Mark	37
Closed Caption	37
DivX Registration	37
Netflix Deactivate	37
PIP Mark	37
Receive Legacy Remocon	37
Remote ID (Unit side)	37
Secondary Audio Mark	37

 P

Picture control	23
Picture-in-Picture	14, 24, 52
Playback	
BD and DVD-Video	14
CD	16
DVD-Audio	16
Files	28
Kodak Picture CD	30
Playlist	30
Super Audio CD	15
Pop up menu	7, 14, 30, 52
Primary audio	19, 52
Primary subtitle	20, 52
Primary video	14, 52
Progressive	22, 37, 52
Proxy	36, 52
Pure direct	21

**R**

- Ratings ..... 35, 52
  - BD Rating Level ..... 35
  - Change Password ..... 35
  - Country Code ..... 35
  - DVD Rating Level ..... 35
- Rear panel ..... 42
- Region code ..... 45, 52
- Remote control ..... 43
  - Inserting the batteries ..... 44
  - Remote control setting ..... 44
- Repeat mode ..... 19
- Resume function ..... 17

**S**

- Sampling frequency ..... 46, 52
- Secondary audio ..... 24, 52
- Secondary subtitle ..... 24, 52
- Subnet Mask ..... 36, 52
- Super Audio CD ..... 45, 47
- System
  - Auto Power Mode ..... 34
  - BD Data Utility ..... 34
  - Firmware Update ..... 34
  - HDMI Control ..... 34
  - HDMI Power Off Control ..... 34
  - Initialize ..... 34
  - Power Saving ..... 34
  - Screen Saver ..... 34
  - Update Notification ..... 34
- System Information ..... 39
  - MAC Address ..... 39

**T**

- Title ..... 47, 52
- Track ..... 47
- TV
  - Progressive Mode ..... 37
  - TV Aspect ..... 37
  - Wallpaper ..... 37

**U**

- USB memory device ..... 14, 26, 45

**V**

- Video resolution ..... 22
- Video Setting ..... 37

**W**

- WMA ..... 46, 52

**X**

- x.v.Color ..... 52

**Y**

- YouTube ..... 31, 52

# License

This section describes software license used for DBP-1611UD. To maintain the correct content, the original (English) is used.

## □ Exhibit-A

### GNU GENERAL PUBLIC LICENSE

Version 2, June 1991

Copyright (C) 1989, 1991

Free Software Foundation, Inc., 51 Franklin Street, Fifth Floor, Boston, MA 02110-1301 USA

Everyone is permitted to copy and distribute verbatim copies of this license document, but changing it is not allowed.

#### Preamble

The licenses for most software are designed to take away your freedom to share and change it. By contrast, the GNU General Public License is intended to guarantee your freedom to share and change free software—to make sure the software is free for all its users. This General Public License applies to most of the Free Software Foundation's software and to any other program whose authors commit to using it. (Some other Free Software Foundation software is covered by the GNU Library General Public License instead.) You can apply it to your programs, too.

When we speak of free software, we are referring to freedom, not price. Our General Public Licenses are designed to make sure that you have the freedom to distribute copies of free software (and charge for this service if you wish), that you receive source code or can get it if you want it, that you can change the software or use pieces of it in new free programs; and that you know you can do these things.

To protect your rights, we need to make restrictions that forbid anyone to deny you these rights or to ask you to surrender the rights. These restrictions translate to certain responsibilities for you if you distribute copies of the software, or if you modify it.

For example, if you distribute copies of such a program, whether gratis or for a fee, you must give the recipients all the rights that you have. You must make sure that they, too, receive or can get the source code. And you must show them these terms so they know their rights.

We protect your rights with two steps: (1) copyright the software, and (2) offer you this license which gives you legal permission to copy, distribute and/or modify the software.

Also, for each author's protection and ours, we want to make certain that everyone understands that there is no warranty for this free software. If the software is modified by someone else and passed on, we want its recipients to know that what they have is not the original, so that any problems introduced by others will not reflect on the original authors' reputations.

Finally, any free program is threatened constantly by software patents. We wish to avoid the danger that redistributors of a free program will individually obtain patent licenses, in effect making the program proprietary. To prevent this, we have made it clear that any patent must be licensed for everyone's free use or not licensed at all. The precise terms and conditions for copying, distribution and modification follow.

### GNU GENERAL PUBLIC LICENSE TERMS AND CONDITIONS FOR COPYING, DISTRIBUTION AND MODIFICATION

0. This License applies to any program or other work which contains a notice placed by the copyright holder saying it may be distributed under the terms of this General Public License. The "Program", below, refers to any such program or work, and a "work based on the Program" means either the Program or any derivative work under copyright law: that is to say, a work containing the Program or a portion of it, either verbatim or with modifications and/or translated into another language. (Hereinafter, translation is included without limitation in the term "modification".) Each licensee is addressed as "you".

Activities other than copying, distribution and modification are not covered by this License; they are outside its scope. The act of running the Program is not restricted, and the output from the Program is covered only if its contents constitute a work based on the Program (independent of having been made by running the Program). Whether that is true depends on what the Program does.

1. You may copy and distribute verbatim copies of the Program's source code as you receive it, in any medium, provided that you conspicuously and appropriately publish on each copy an appropriate copyright notice and disclaimer of warranty; keep intact all the notices that refer to this License and to the absence of any warranty; and give any other recipients of the Program a copy of this License along with the Program.

You may charge a fee for the physical act of transferring a copy, and you may at your option offer warranty protection in exchange for a fee.

2. You may modify your copy or copies of the Program or any portion of it, thus forming a work based on the Program, and copy and distribute such modifications or work under the terms of Section 1 above, provided that you also meet all of these conditions:

a) You must cause the modified files to carry prominent notices stating that you changed the files and the date of any change.

b) You must cause any work that you distribute or publish, that in whole or in part contains or is derived from the Program or any part thereof, to be licensed as a whole at no charge to all third parties under the terms of this License.

c) If the modified program normally reads commands interactively when run, you must cause it, when started running for such interactive use in the most ordinary way, to print or display an announcement including an appropriate copyright notice and a notice that there is no warranty (or else, saying that you provide a warranty) and that users may redistribute the program under these conditions, and telling the user how to view a copy of this License.

(Exception: if the Program itself is interactive but does not normally print such an announcement, your work based on the Program is not required to print an announcement.)

These requirements apply to the modified work as a whole. If identifiable sections of that work are not derived from the Program, and can be reasonably considered independent and separate works in themselves, then this License, and its terms, do not apply to those sections when you distribute them as separate works. But when you distribute the same sections as part of a whole which is a work based on the Program, the distribution of the whole must be on the terms of this License, whose permissions for other licensees extend to the entire whole, and thus to each and every part regardless of who wrote it.

Thus, it is not the intent of this section to claim rights or contest your rights to work written entirely by you; rather, the intent is to exercise the right to control the distribution of derivative or collective works based on the Program.

In addition, mere aggregation of another work not based on the Program with the Program (or with a work based on the Program) on a volume of a storage or distribution medium does not bring the other work under the scope of this License.

3. You may copy and distribute the Program (or a work based on it, under Section 2) in object code or executable form under the terms of Sections 1 and 2 above provided that you also do one of the following:

a) Accompany it with the complete corresponding machine-readable source code, which must be distributed under the terms of Sections 1 and 2 above on a medium customarily used for software interchange; or,

b) Accompany it with a written offer, valid for at least three years, to give any third party, for a charge no more than your cost of physically performing source distribution, a complete machine-readable copy of the corresponding source code, to be distributed under the terms of Sections 1 and 2 above on a medium customarily used for software interchange; or,

c) Accompany it with the information you received as to the offer to distribute corresponding source code. (This alternative is allowed only for noncommercial distribution and only if you received the program in object code or executable form with such an offer, in accord with Subsection b above.)

The source code for a work means the preferred form of the work for making modifications to it. For an executable work, complete source code means all the source code for all modules it contains, plus any associated interface definition files, plus the scripts used to control compilation and installation of the executable.

However, as a special exception, the source code distributed need not include anything that is normally distributed (in either source or binary form) with the major components (compiler, kernel, and so on) of the operating system on which the executable runs, unless that component itself accompanies the executable.

If distribution of executable or object code is made by offering access to copy from a designated place, then offering equivalent access to copy the source code from the same place counts as distribution of the source code, even though third parties are not compelled to copy the source along with the object code.

4. You may not copy, modify, sublicense, or distribute the Program except as expressly provided under this License. Any attempt otherwise to copy, modify, sublicense or distribute the Program is void, and will automatically terminate your rights under this License. However, parties who have received copies, or rights, from you under this License will not have their licenses terminated so long as such parties remain in full compliance.

5. You are not required to accept this License, since you have not signed it. However, nothing else grants you permission to modify or distribute the Program or its derivative works. These actions are prohibited by law if you do not accept this License. Therefore, by modifying or distributing the Program (or any work based on the Program), you indicate your acceptance of this License to do so, and all its terms and conditions for copying, distributing or modifying the Program or works based on it.

6. Each time you redistribute the Program (or any work based on the Program), the recipient automatically receives a license from the original licensor to copy, distribute or modify the Program subject to these terms and conditions. You may not impose any further restrictions on the recipients' exercise of the rights granted herein.

You are not responsible for enforcing compliance by third parties to this License.

7. If, as a consequence of a court judgment or allegation of patent infringement or for any other reason (not limited to patent issues), conditions are imposed on you (whether by court order, agreement or otherwise) that contradict the conditions of this License, they do not excuse you from the conditions of this License. If you cannot distribute so as to satisfy simultaneously your obligations under this License and any other pertinent obligations, then as a consequence you may not distribute the Program at all. For example, if a patent license would not permit royalty-free redistribution of the Program by all those who receive copies directly or indirectly through you, then the only way you could satisfy both it and this License would be to refrain entirely from distribution of the Program. If any portion of this section is held invalid or unenforceable under any particular circumstance, the balance of the section is intended to apply and the section as a whole is intended to apply in other circumstances.

It is not the purpose of this section to induce you to infringe any patents or other property right claims or to contest validity of any such claims; this section has the sole purpose of protecting the integrity of the free software distribution system, which is implemented by public license practices. Many people have made generous contributions to the wide range of software distributed through that system in reliance on consistent application of that system; it is up to the author/donor to decide if he or she is willing to distribute software through any other system and a licensee cannot impose that choice.

This section is intended to make thoroughly clear what is believed to be a consequence of the rest of this License.

8. If the distribution and/or use of the Program is restricted in certain countries either by patents or by copyrighted interfaces, the original copyright holder who places the Program under this License may add an explicit geographical distribution limitation excluding those countries, so that distribution is permitted only in or among countries not thus excluded. In such case, this License incorporates the limitation as if written in the body of this License.
9. The Free Software Foundation may publish revised and/or new versions of the General Public License from time to time. Such new versions will be similar in spirit to the present version, but may differ in detail to address new problems or concerns. Each version is given a distinguishing version number. If the Program specifies a version number of this License which applies to it and "any later version", you have the option of following the terms and conditions either of that version or of any later version published by the Free Software Foundation. If the Program does not specify a version number of this License, you may choose any version ever published by the Free Software Foundation.
10. If you wish to incorporate parts of the Program into other free programs whose distribution conditions are different, write to the author to ask for permission. For software which is copyrighted by the Free Software Foundation, write to the Free Software Foundation; we sometimes make exceptions for this. Our decision will be guided by the two goals of preserving the free status of all derivatives of our free software and of promoting the sharing and reuse of software generally.

#### NO WARRANTY

11. BECAUSE THE PROGRAM IS LICENSED FREE OF CHARGE, THERE IS NO WARRANTY FOR THE PROGRAM, TO THE EXTENT PERMITTED BY APPLICABLE LAW. EXCEPT WHEN OTHERWISE STATED IN WRITING THE COPYRIGHT HOLDERS AND/OR OTHER PARTIES PROVIDE THE PROGRAM "AS IS" WITHOUT WARRANTY OF ANY KIND, EITHER EXPRESSED OR IMPLIED, INCLUDING, BUT NOT LIMITED TO, THE IMPLIED WARRANTIES OF MERCHANTABILITY AND FITNESS FOR A PARTICULAR PURPOSE. THE ENTIRE RISK AS TO THE QUALITY AND PERFORMANCE OF THE PROGRAM IS WITH YOU. SHOULD THE PROGRAM PROVE DEFECTIVE, YOU ASSUME THE COST OF ALL NECESSARY SERVICING, REPAIR OR CORRECTION.
12. IN NO EVENT UNLESS REQUIRED BY APPLICABLE LAW OR AGREED TO IN WRITING WILL ANY COPYRIGHT HOLDER, OR ANY OTHER PARTY WHO MAY MODIFY AND/OR REDISTRIBUTE THE PROGRAM AS PERMITTED ABOVE, BE LIABLE TO YOU FOR DAMAGES, INCLUDING ANY GENERAL, SPECIAL, INCIDENTAL OR CONSEQUENTIAL DAMAGES ARISING OUT OF THE USE OR INABILITY TO USE THE PROGRAM (INCLUDING BUT NOT LIMITED TO LOSS OF DATA OR DATA BEING RENDERED INACCURATE OR LOSSES SUSTAINED BY YOU OR THIRD PARTIES OR A FAILURE OF THE PROGRAM TO OPERATE WITH ANY OTHER PROGRAMS), EVEN IF SUCH HOLDER OR OTHER PARTY HAS BEEN ADVISED OF THE POSSIBILITY OF SUCH DAMAGES.

#### END OF TERMS AND CONDITIONS

##### How to Apply These Terms to Your New Programs

If you develop a new program, and you want it to be of the greatest possible use to the public, the best way to achieve this is to make it free software which everyone can redistribute and change under these terms.

To do so, attach the following notices to the program. It is safest to attach them to the start of each source file to most effectively convey the exclusion of warranty; and each file should have at least the "copyright" line and a pointer to where the full notice is found.

<one line to give the program's name and a brief idea of what it does.>

Copyright (C) <year> <name of author>

This program is free software; you can redistribute it and/or modify it under the terms of the GNU General Public License as published by the Free Software Foundation; either version 2 of the License, or (at your option) any later version.

This program is distributed in the hope that it will be useful, but WITHOUT ANY WARRANTY; without even the implied warranty of MERCHANTABILITY or FITNESS FOR A PARTICULAR PURPOSE. See the GNU General Public License for more details.

You should have received a copy of the GNU General Public License along with this program; if not, write to the Free Software Foundation, Inc., 51 Franklin Street, Fifth Floor, Boston, MA 02110-1301 USA

Also add information on how to contact you by electronic and paper mail.

If the program is interactive, make it output a short notice like this when it starts in an interactive mode:

Gnomovision version 69, Copyright (C) year name of author

Gnomovision comes with ABSOLUTELY NO WARRANTY; for details type 'show w'. This is free software, and you are welcome to redistribute it under certain conditions; type 'show c' for details.

The hypothetical commands 'show w' and 'show c' should show the appropriate parts of the General Public License. Of course, the commands you use may be called something other than 'show w' and 'show c'; they could even be mouse-clicks or menu items--whatever suits your program.

You should also get your employer (if you work as a programmer) or your school, if any, to sign a "copyright disclaimer" for the program, if necessary. Here is a sample; alter the names:

Yoyodyne, Inc., hereby disclaims all copyright interest in the program 'Gnomovision' (which makes passes at compilers) written by James Hacker.

<signature of Ty Coon>, 1 April 1989

Ty Coon, President of Vice

This General Public License does not permit incorporating your program into proprietary programs. If your program is a subroutine library, you may consider it more useful to permit linking proprietary applications with the library. If this is what you want to do, use the GNU Library General Public License instead of this License.

#### Exhibit-B

##### GNU LESSER GENERAL PUBLIC LICENSE

Version 2.1, February 1999

Copyright (C) 1991, 1999 Free Software Foundation, Inc.  
51 Franklin Street, Fifth Floor, Boston, MA 02110-1301 USA

Everyone is permitted to copy and distribute verbatim copies of this license document, but changing it is not allowed.

[This is the first released version of the Lesser GPL. It also counts as the successor of the GNU Library Public License, version 2, hence the version number 2.1.]

##### Preamble

The licenses for most software are designed to take away your freedom to share and change it. By contrast, the GNU General Public Licenses are intended to guarantee your freedom to share and change free software--to make sure the software is free for all its users.

This license, the Lesser General Public License, applies to some specially designated software packages--typically libraries--of the Free Software Foundation and other authors who decide to use it. You can use it too, but we suggest you first think carefully about whether this license or the ordinary General Public License is the better strategy to use in any particular case, based on the explanations below.

When we speak of free software, we are referring to freedom of use, not price. Our General Public Licenses are designed to make sure that you have the freedom to distribute copies of free software (and charge for this service if you wish); that you receive source code or can get it if you want it; that you can change the software and use pieces of it in new free programs; and that you are informed that you can do these things.

To protect your rights, we need to make restrictions that forbid distributors to deny you these rights or to ask you to surrender these rights. These restrictions translate to certain responsibilities for you if you distribute copies of the library or if you modify it.

For example, if you distribute copies of the library, whether gratis or for a fee, you must give the recipients all the rights that we gave you. You must make sure that they, too, receive or can get the source code. If you link other code with the library, you must provide complete object files to the recipients, so that they can relink them with the library after making changes to the library and recompiling it. And you must show them these terms so they know their rights. We protect your rights with a two-step method: (1) we copyright the library, and (2) we offer you this license, which gives you legal permission to copy, distribute and/or modify the library.

To protect each distributor, we want to make it very clear that there is no warranty for the free library. Also, if the library is modified by someone else and passed on, the recipients should know that what they have is not the original version, so that the original author's reputation will not be affected by problems that might be introduced by others.

Finally, software patents pose a constant threat to the existence of any free program. We wish to make sure that a company cannot effectively restrict the users of a free program by obtaining a restrictive license from a patent holder. Therefore, we insist that any patent license obtained for a version of the library must be consistent with the full freedom of use specified in this license.

Most GNU software, including some libraries, is covered by the ordinary GNU General Public License. This license, the GNU Lesser General Public License, applies to certain designated libraries, and is quite different from the ordinary General Public License. We use this license for certain libraries in order to permit linking those libraries into non-free programs.

When a program is linked with a library, whether statically or using a shared library, the combination of the two is legally speaking a combined work, a derivative of the original library. The ordinary General Public License therefore permits such linking only if the entire combination fits its criteria of freedom. The Lesser General Public License permits more lax criteria for linking other code with the library.

We call this license the "Lesser" General Public License because it does Less to protect the user's freedom than the ordinary General Public License. It also provides other free software developers Less of an advantage over competing non-free programs. These disadvantages are the reason we use the ordinary General Public License for many libraries. However, the Lesser license provides advantages in certain special circumstances.

For example, on rare occasions, there may be a special need to encourage the widest possible use of a certain library, so that it becomes a de-facto standard. To achieve this, non-free programs must be allowed to use the library. A more frequent case is that a free library does the same job as widely used non-free libraries. In this case, there is little to gain by limiting the free library to free software only, so we use the Lesser General Public License.

In other cases, permission to use a particular library in non-free programs enables a greater number of people to use a large body of free software. For example, permission to use the GNU C Library in non-free programs enables many more people to use the whole GNU operating system, as well as its variant, the GNU/Linux operating system.

Although the Lesser General Public License is Less protective of the users' freedom, it does ensure that the user of a program that is linked with the Library has the freedom and the wherewithal to run that program using a modified version of the Library.

The precise terms and conditions for copying, distribution and modification follow. Pay close attention to the difference between a "work based on the library" and a "work that uses the library".

The former contains code derived from the library, whereas the latter must be combined with the library in order to run.



**GNU LESSER GENERAL PUBLIC LICENSE  
TERMS AND CONDITIONS FOR COPYING, DISTRIBUTION  
AND MODIFICATION**

0. This License Agreement applies to any software library or other program which contains a notice placed by the copyright holder or other authorized party saying it may be distributed under the terms of this Lesser General Public License (also called "this License").

Each licensee is addressed as "you".

A "library" means a collection of software functions and/or data prepared so as to be conveniently linked with application programs (which use some of those functions and data) to form executables.

The "Library", below, refers to any such software library or work which has been distributed under these terms. A "work based on the Library" means either the Library or any derivative work under copyright law: that is to say, a work containing the Library or a portion of it, either verbatim or with modifications and/or translated straightforwardly into another language. (Hereinafter, translation is included without limitation in the term "modification".)

"Source code" for a work means the preferred form of the work for making modifications to it. For a library, complete source code means all the source code for all modules it contains, plus any associated interface definition files, plus the scripts used to control compilation and installation of the library.

Activities other than copying, distribution and modification are not covered by this License; they are outside its scope. The act of running a program using the Library is not restricted, and output from such a program is covered only if its contents constitute a work based on the Library (independent of the use of the Library in a tool for writing it). Whether that is true depends on what the Library does and what the program that uses the Library does.

1. You may copy and distribute verbatim copies of the Library's complete source code as you receive it, in any medium, provided that you conspicuously and appropriately publish on each copy an appropriate copyright notice and disclaimer of warranty; keep intact all the notices that refer to this License and to the absence of any warranty; and distribute a copy of this License along with the Library.

You may charge a fee for the physical act of transferring a copy, and you may at your option offer warranty protection in exchange for a fee.

2. You may modify your copy or copies of the Library or any portion of it, thus forming a work based on the Library, and copy and distribute such modifications or work under the terms of Section 1 above, provided that you also meet all of these conditions:

a) The modified work must itself be a software library.  
b) You must cause the files modified to carry prominent notices stating that you changed the files and the date of any change.

c) You must cause the whole of the work to be licensed at no charge to all third parties under the terms of this License.

d) If a facility in the modified Library refers to a function or a table of data to be supplied by an application program that uses the facility, other than an argument passed when the facility is invoked, then you must make a good faith effort to ensure that,

in the event an application does not supply such function or table, the facility still operates, and performs whatever part of its purpose remains meaningful.

(For example, a function in a library to compute square roots has a purpose that is entirely well-defined independent of the application. Therefore, Subsection 2d requires that any application-supplied function or table used by this function must be optional: if the application does not supply it, the square root function must still compute square roots.)

These requirements apply to the modified work as a whole. If identifiable sections of that work are not derived from the Library, and can be reasonably considered independent and separate works in themselves, then this License, and its terms, do not apply to those sections when you distribute them as separate works. But when you distribute the same sections as part of a whole which is a work based on the Library, the distribution of the whole must be on the terms of this License, whose permissions for other licensees extend to the entire whole, and thus to each and every part regardless of who wrote it.

Thus, it is not the intent of this section to claim rights or contest your rights to work written entirely by you; rather, the intent is to exercise the right to control the distribution of derivative or collective works based on the Library.

In addition, mere aggregation of another work not based on the Library with the Library (or with a work based on the Library) on a volume of a storage or distribution medium does not bring the other work under the scope of this License.

3. You may opt to apply the terms of the ordinary GNU General Public License instead of this License to a given copy of the Library. To do this, you must alter all the notices that refer to this License, so that they refer to the ordinary GNU General Public License, version 2, instead of to this License. (If a newer version than version 2 of the ordinary GNU General Public License has appeared, then you can specify that version instead if you wish.) Do not make any other change in these notices.

Once this change is made in a given copy, it is irreversible for that copy, so the ordinary GNU General Public License applies to all subsequent copies and derivative works made from that copy.

This option is useful when you wish to copy part of the code of the Library into a program that is not a library.

4. You may copy and distribute the Library (or a portion or derivative of it, under Section 2) in object code or executable form under the terms of Sections 1 and 2 above provided that you accompany it with the complete corresponding machine-readable source code, which must be distributed under the terms of Sections 1 and 2 above on a medium customarily used for software interchange.

If distribution of object code is made by offering access to copy from a designated place, then offering equivalent access to copy the source code from the same place satisfies the requirement to distribute the source code, even though third parties are not compelled to copy the source along with the object code.

5. A program that contains no derivative of any portion of the Library, but is designed to work with the Library by being compiled or linked with it, is called a "work that uses the Library". Such a work, in isolation, is not a derivative work of the Library, and therefore falls outside the scope of this License.

However, linking a "work that uses the Library" with the Library creates an executable that is a derivative of the Library (because it contains portions of the Library), rather than a "work that uses the library". The executable is therefore covered by this License.

Section 6 states terms for distribution of such executables.

When a "work that uses the Library" uses material from a header file that is part of the Library, the object code for the work may be a derivative work of the Library even though the source code is not.

Whether this is true is especially significant if the work can be linked without the Library, or if the work is itself a library. The threshold for this to be true is not precisely defined by law.

If such an object file uses only numerical parameters, data structure layouts and accessors, and small macros and small inline functions (ten lines or less in length), then the use of the object file is unrestricted, regardless of whether it is legally a derivative work. (Executables containing this object code plus portions of the Library will still fall under Section 6.)

Otherwise, if the work is a derivative of the Library, you may distribute the object code for the work under the terms of Section 6. Any executables containing that work also fall under Section 6, whether or not they are linked directly with the Library itself.

6. As an exception to the Sections above, you may also combine or link a "work that uses the Library" with the Library to produce a work containing portions of the Library, and distribute that work under terms of your choice, provided that the terms permit modification of the work for the customer's own use and reverse engineering for debugging such modifications.

You must give prominent notice with each copy of the work that the Library is used in it and that the Library and its use are covered by this License. You must supply a copy of this License. If the work during execution displays copyright notices, you must include the copyright notice for the Library among them, as well as a reference directing the user to the copy of this License. Also, you must do one of these things:

a) Accompany the work with the complete corresponding machine-readable source code for the Library including whatever changes were used in the work (which must be distributed under Sections 1 and 2 above); and, if the work is an executable linked with the Library, with the complete machine-readable "work that uses the Library", as object code and/or source code, so that the user can modify the Library and then relink to produce a modified executable containing the modified Library. (It is understood that the user who changes the contents of definitions files in the Library will not necessarily be able to recompile the application to use the modified definitions.)

b) Use a suitable shared library mechanism for linking with the Library. A suitable mechanism is one that (1) uses at run time a copy of the library already present on the user's computer system, rather than copying library functions into the executable, and (2) will operate properly with a modified version of the library, if the user installs one, as long as the modified version is interface-compatible with the version that the work was made with.

c) Accompany the work with a written offer, valid for at least three years, to give the same user the materials specified in Subsection 6a, above, for a charge no more than the cost of performing this distribution.

d) If distribution of the work is made by offering access to copy from a designated place, offer equivalent access to copy the above specified materials from the same place.

e) Verify that the user has already received a copy of these materials or that you have already sent this user a copy.

For an executable, the required form of the "work that uses the Library" must include any data and utility programs needed for reproducing the executable from it. However, as a special exception, the materials to be distributed need not include anything that is normally distributed (in either source or binary form) with the major components (compiler, kernel, and so on) of the operating system on which the executable runs, unless that component itself accompanies the executable.

It may happen that this requirement contradicts the license restrictions of other proprietary libraries that do not normally accompany the operating system. Such a contradiction means you cannot use both them and the Library together in an executable that you distribute.

7. You may place library facilities that are a work based on the Library side-by-side in a single library together with other library facilities not covered by this License, and distribute such a combined library, provided that the separate distribution of the work based on the Library and of the other library facilities is otherwise permitted, and provided that you do these two things:

a) Accompany the combined library with a copy of the same work based on the Library, uncombined with any other library facilities. This must be distributed under the terms of the Sections above.

b) Give prominent notice with the combined library of the fact that part of it is a work based on the Library, and explaining where to find the accompanying uncombined form of the same work.

8. You may not copy, modify, sublicense, link with, or distribute the Library except as expressly provided under this License. Any attempt otherwise to copy, modify, sublicense, link with, or distribute the Library is void, and will automatically terminate your rights under this License. However, parties who have received copies, or rights, from you under this License will not have their licenses terminated so long as such parties remain in full compliance.

9. You are not required to accept this License, since you have not signed it. However, nothing else grants you permission to modify or distribute the Library or its derivative works. These actions are prohibited by law if you do not accept this License. Therefore, by modifying or distributing the Library (or any work based on the Library), you indicate your acceptance of this License to do so, and all its terms and conditions for copying, distributing or modifying the Library or works based on it.
10. Each time you redistribute the Library (or any work based on the Library), the recipient automatically receives a license from the original licensor to copy, distribute, link with or modify the Library subject to these terms and conditions. You may not impose any further restrictions on the recipients' exercise of the rights granted herein. You are not responsible for enforcing compliance by third parties with this License.
11. If, as a consequence of a court judgment or allegation of patent infringement or for any other reason (not limited to patent issues), conditions are imposed on you (whether by court order, agreement or otherwise) that contradict the conditions of this License, they do not excuse you from the conditions of this License. If you cannot distribute so as to satisfy simultaneously your obligations under this License and any other pertinent obligations, then as a consequence you may not distribute the Library at all. For example, if a patent license would not permit royalty-free redistribution of the Library by all those who receive copies directly or indirectly through you, then the only way you could satisfy both it and this License would be to refrain entirely from distribution of the Library. If any portion of this section is held invalid or unenforceable under any particular circumstance, the balance of the section is intended to apply, and the section as a whole is intended to apply in other circumstances. It is not the purpose of this section to induce you to infringe any patents or other property right claims or to contest validity of any such claims; this section has the sole purpose of protecting the integrity of the free software distribution system which is implemented by public license practices. Many people have made generous contributions to the wide range of software distributed through that system in reliance on consistent application of that system; it is up to the author/donor to decide if he or she is willing to distribute software through any other system and a licensee cannot impose that choice. This section is intended to make thoroughly clear what is believed to be a consequence of the rest of this License.
12. If the distribution and/or use of the Library is restricted in certain countries either by patents or by copyrighted interfaces, the original copyright holder who places the Library under this License may add an explicit geographical distribution limitation excluding those countries, so that distribution is permitted only in or among countries not thus excluded. In such case, this License incorporates the limitation as if written in the body of this License.

13. The Free Software Foundation may publish revised and/or new versions of the Lesser General Public License from time to time. Such new versions will be similar in spirit to the present version, but may differ in detail to address new problems or concerns. Each version is given a distinguishing version number. If the Library specifies a version number of this License which applies to it and "any later version", you have the option of following the terms and conditions either of that version or of any later version published by the Free Software Foundation. If the Library does not specify a license version number, you may choose any version ever published by the Free Software Foundation.
14. If you wish to incorporate parts of the Library into other free programs whose distribution conditions are incompatible with these, write to the author to ask for permission. For software which is copyrighted by the Free Software Foundation, write to the Free Software Foundation; we sometimes make exceptions for this. Our decision will be guided by the two goals of preserving the free status of all derivatives of our free software and of promoting the sharing and reuse of software generally.

#### NO WARRANTY

15. BECAUSE THE LIBRARY IS LICENSED FREE OF CHARGE, THERE IS NO WARRANTY FOR THE LIBRARY, TO THE EXTENT PERMITTED BY APPLICABLE LAW. EXCEPT WHEN OTHERWISE STATED IN WRITING THE COPYRIGHT HOLDERS AND/OR OTHER PARTIES PROVIDE THE LIBRARY "AS IS" WITHOUT WARRANTY OF ANY KIND, EITHER EXPRESSED OR IMPLIED, INCLUDING, BUT NOT LIMITED TO, THE IMPLIED WARRANTIES OF MERCHANTABILITY AND FITNESS FOR A PARTICULAR PURPOSE. THE ENTIRE RISK AS TO THE QUALITY AND PERFORMANCE OF THE LIBRARY IS WITH YOU. SHOULD THE LIBRARY PROVE DEFECTIVE, YOU ASSUME THE COST OF ALL NECESSARY SERVICING, REPAIR OR CORRECTION.
16. IN NO EVENT UNLESS REQUIRED BY APPLICABLE LAW OR AGREED TO IN WRITING WILL ANY COPYRIGHT HOLDER, OR ANY OTHER PARTY WHO MAY MODIFY AND/OR REDISTRIBUTE THE LIBRARY AS PERMITTED ABOVE, BE LIABLE TO YOU FOR DAMAGES, INCLUDING ANY GENERAL, SPECIAL, INCIDENTAL OR CONSEQUENTIAL DAMAGES ARISING OUT OF THE USE OR INABILITY TO USE THE LIBRARY (INCLUDING BUT NOT LIMITED TO LOSS OF DATA OR DATA BEING RENDERED INACCURATE OR LOSSES SUSTAINED BY YOU OR THIRD PARTIES OR A FAILURE OF THE LIBRARY TO OPERATE WITH ANY OTHER SOFTWARE), EVEN IF SUCH HOLDER OR OTHER PARTY HAS BEEN ADVISED OF THE POSSIBILITY OF SUCH DAMAGES.

#### END OF TERMS AND CONDITIONS

##### How to Apply These Terms to Your New Libraries

If you develop a new library, and you want it to be of the greatest possible use to the public, we recommend making it free software that everyone can redistribute and change. You can do so by permitting redistribution under these terms (or, alternatively, under the terms of the ordinary General Public License).

To apply these terms, attach the following notices to the library. It is safest to attach them to the start of each source file to most effectively convey the exclusion of warranty; and each file should have at least the "copyright" line and a pointer to where the full notice is found.

<one line to give the library's name and a brief idea of what it does.>

Copyright (C) <year> <name of author>

This library is free software; you can redistribute it and/or modify it under the terms of the GNU Lesser General Public License as published by the Free Software Foundation; either version 2.1 of the License, or (at your option) any later version.

This library is distributed in the hope that it will be useful, but WITHOUT ANY WARRANTY; without even the implied warranty of MERCHANTABILITY or FITNESS FOR A PARTICULAR PURPOSE. See the GNU Lesser General Public License for more details.

You should have received a copy of the GNU Lesser General Public License along with this library; if not, write to the Free Software Foundation, Inc., 51 Franklin Street, Fifth Floor, Boston, MA 02110-1301 USA

Also add information on how to contact you by electronic and paper mail.

You should also get your employer (if you work as a programmer) or your school, if any, to sign a "copyright disclaimer" for the library, if necessary. Here is a sample; alter the names:

Yoyodyne, Inc., hereby disclaims all copyright interest in the library 'Frob' (a library for tweaking knobs) written by James Random Hacker.

<signature of Ty Coon>, 1 April 1990

Ty Coon, President of Vice

That's all there is to it!

#### Exhibit-C

/\* zlib.h -- interface of the 'zlib' general purpose compression library version 1.2.3, July 18th, 2005

Copyright (C) 1995-2005 Jean-loup Gailly and Mark Adler

This software is provided 'as-is', without any express or implied warranty. In no event will the authors be held liable for any damages arising from the use of this software.

Permission is granted to anyone to use this software for any purpose, including commercial applications, and to alter it and redistribute it freely, subject to the following restrictions:

1. The origin of this software must not be misrepresented; you must not claim that you wrote the original software. If you use this software in a product, an acknowledgment in the product documentation would be appreciated but is not required.
2. Altered source versions must be plainly marked as such, and must not be misrepresented as being the original software.
3. This notice may not be removed or altered from any source distribution.  
Jean-loup Gailly jloup@gzip.org  
Mark Adler madler@alumni.caltech.edu

\*/

#### Exhibit-D

Copyright (c) 1998, 1999, 2000 Thai Open Source Software Center Ltd and Clark Cooper

Copyright (c) 2001, 2002, 2003, 2004, 2005, 2006 Expat maintainers.

Permission is hereby granted, free of charge, to any person obtaining a copy of this software and associated documentation files (the Software), to deal in the Software without restriction, including without limitation the rights to use, copy, modify, merge, publish, distribute, sublicense, and/or sell copies of the Software, and to permit persons to whom the Software is furnished to do so, subject to the following conditions:

The above copyright notice and this permission notice shall be included in all copies or substantial portions of the Software.

THE SOFTWARE IS PROVIDED "AS IS", WITHOUT WARRANTY OF ANY KIND, EXPRESS OR IMPLIED, INCLUDING BUT NOT LIMITED TO THE WARRANTIES OF MERCHANTABILITY, FITNESS FOR A PARTICULAR PURPOSE AND NONINFRINGEMENT.

IN NO EVENT SHALL THE AUTHORS OR COPYRIGHT HOLDERS BE LIABLE FOR ANY CLAIM, DAMAGES OR OTHER LIABILITY, WHETHER IN AN ACTION OF CONTRACT, TORT OR OTHERWISE, ARISING FROM, OUT OF OR IN CONNECTION WITH THE SOFTWARE OR THE USE OR OTHER DEALINGS IN THE SOFTWARE.

#### Exhibit-E

##### The FreeType Project LICENSE

2006-Jan-27

Copyright 1996-2002, 2006 by

David Turner, Robert Wilhelm, and Werner Lemberg

##### Introduction

The FreeType Project is distributed in several archive packages; some of them may contain, in addition to the FreeType font engine, various tools and contributions which rely on, or relate to, the FreeType Project.

This license applies to all files found in such packages, and which do not fall under their own explicit license. The license affects thus the FreeType font engine, the test programs, documentation and makefiles, at the very least. This license was inspired by the BSD, Artistic, and IJG (Independent JPEG Group) licenses, which all encourage inclusion and use of free software in commercial and freeware products alike. As a consequence, its main points are that:

- We don't promise that this software works. However, we will be interested in any kind of bug reports. ('as is' distribution)
- You can use this software for whatever you want, in parts or full form, without having to pay us. ('royalty-free' usage)
- You may not pretend that you wrote this software. If you use it, or only parts of it, in a program, you must acknowledge somewhere in your documentation that you have used the FreeType code. ('credits')

We specifically permit and encourage the inclusion of this software, with or without modifications, in commercial products.

We disclaim all warranties covering The FreeType Project and assume no liability related to The FreeType Project.

Finally, many people asked us for a preferred form for a credit/disclaimer to use in compliance with this license. We thus encourage you to use the following text:

```
“ “ “
Portions of this software are copyright c <year> The
FreeType Project (www.freetype.org). All rights reserved.
“ “ “
```

Please replace <year> with the value from the FreeType version you actually use.

## Legal Terms

### 0. Definitions

Throughout this license, the terms 'package', 'FreeType Project', and 'FreeType archive' refer to the set of files originally distributed by the authors (David Turner, Robert Wilhelm, and Werner Lemberg) as the 'FreeType Project', be they named as alpha, beta or final release.

'You' refers to the licensee, or person using the project, where 'using' is a generic term including compiling the project's source code as well as linking it to form a 'program' or 'executable'.

This program is referred to as 'a program using the FreeType engine'.

This license applies to all files distributed in the original FreeType Project, including all source code, binaries and documentation, unless otherwise stated in the file in its original, unmodified form a distributed in the original archive.

If you are unsure whether or not a particular file is covered by this license, you must contact us to verify this.

The FreeType Project is copyright (C) 1996-2000 by David Turner, Robert Wilhelm, and Werner Lemberg. All rights reserved except as specified below.

### 1. No Warranty

THE FREETYPE PROJECT IS PROVIDED 'AS IS' WITHOUT WARRANTY OF ANY KIND, EITHER EXPRESS OR IMPLIED, INCLUDING, BUT NOT LIMITED TO, WARRANTIES OF MERCHANTABILITY AND FITNESS FOR A PARTICULAR PURPOSE. IN NO EVENT WILL ANY OF THE AUTHORS OR COPYRIGHT HOLDERS BE LIABLE FOR ANY DAMAGES CAUSED BY THE USE OR THE INABILITY TO USE, OF THE FREETYPE PROJECT.

### 2. Redistribution

This license grants a worldwide, royalty-free, perpetual and irrevocable right and license to use, execute, perform, compile, display, copy, create derivative works of, distribute and sublicense the FreeType Project (in both source and object code forms) and derivative works thereof for any purpose; and to authorize others to exercise some or all of the rights granted herein, subject to the following conditions:

- Redistribution of source code must retain this license file ('FTL.TXT') unaltered; any additions, deletions or changes to the original files must be clearly indicated in accompanying documentation. The copyright notices of the unaltered, original files must be preserved in all copies of source files.
- Redistribution in binary form must provide a disclaimer that states that the software is based in part of the work of the FreeType Team, in the distribution documentation. We also encourage you to put an URL to the FreeType web page in your documentation, though this isn't mandatory.

These conditions apply to any software derived from or based on the FreeType Project, not just the unmodified files. If you use our work, you must acknowledge us. However, no fee need be paid to us.

### 3. Advertising

Neither the FreeType authors and contributors nor you shall use the name of the other for commercial, advertising, or promotional purposes without specific prior written permission.

We suggest, but do not require, that you use one or more of the following phrases to refer to this software in your documentation or advertising materials: 'FreeType Project', 'FreeType Engine', 'FreeType library', or 'FreeType Distribution'.

As you have not signed this license, you are not required to accept it. However, as the FreeType Project is copyrighted material, only this license, or another one contracted with the authors, grants you the right to use, distribute, and modify it.

Therefore, by using, distributing, or modifying the FreeType Project, you indicate that you understand and accept all the terms of this license.

### 4. Contacts

There are two mailing lists related to FreeType:

- [freetype@freetype.org](mailto:freetype@freetype.org)  
Discusses general use and applications of FreeType, as well as future and wanted additions to the library and distribution.  
If you are looking for support, start in this list if you haven't found anything to help you in the documentation.
- [freetype-devel@nongnu.org](mailto:freetype-devel@nongnu.org)  
Discusses bugs, as well as engine internals, design issues, specific licenses, porting, etc.

Our home page can be found at

<http://www.freetype.org>

-- end of FTLTXT --

## Exhibit-F LICENSE ISSUES

The OpenSSL toolkit stays under a dual license, i.e. both the conditions of the OpenSSL License and the original SSLeay license apply to the toolkit.

See below for the actual license texts. Actually both licenses are BSD-style Open Source licenses. In case of any license issues related to OpenSSL please contact [openssl-core@openssl.org](mailto:openssl-core@openssl.org).

### OpenSSL License

```
/*=====
Copyright (c) 1998-2008 The OpenSSL Project. All rights
reserved.
```

Redistribution and use in source and binary forms, with or without modification, are permitted provided that the following conditions are met:

1. Redistributions of source code must retain the above copyright notice, this list of conditions and the following disclaimer.
2. Redistributions in binary form must reproduce the above copyright notice, this list of conditions and the following disclaimer in the documentation and/or other materials provided with the distribution.
3. All advertising materials mentioning features or use of this software must display the following acknowledgment:  
"This product includes software developed by the OpenSSL Project for use in the OpenSSL Toolkit (<http://www.openssl.org/>)"
4. The names "OpenSSL Toolkit" and "OpenSSL Project" must not be used to endorse or promote products derived from this software without prior written permission. For written permission, please contact [openssl-core@openssl.org](mailto:openssl-core@openssl.org).
5. Products derived from this software may not be called "OpenSSL" nor may "OpenSSL" appear in their names without prior written permission of the OpenSSL Project.
6. Redistributions of any form whatsoever must retain the following acknowledgment:  
"This product includes software developed by the OpenSSL Project for use in the OpenSSL Toolkit (<http://www.openssl.org/>)"

THIS SOFTWARE IS PROVIDED BY THE OpenSSL PROJECT "AS IS" AND ANY EXPRESSED OR IMPLIED WARRANTIES, INCLUDING, BUT NOT LIMITED TO, THE IMPLIED WARRANTIES OF MERCHANTABILITY AND FITNESS FOR A PARTICULAR PURPOSE ARE DISCLAIMED.

IN NO EVENT SHALL THE OpenSSL PROJECT OR ITS CONTRIBUTORS BE LIABLE FOR ANY DIRECT, INDIRECT, INCIDENTAL, SPECIAL, EXEMPLARY, OR CONSEQUENTIAL DAMAGES (INCLUDING, BUT NOT LIMITED TO, PROCUREMENT OF SUBSTITUTE GOODS OR SERVICES; LOSS OF USE, DATA, OR PROFITS; OR BUSINESS INTERRUPTION) HOWEVER CAUSED AND ON ANY THEORY OF LIABILITY, WHETHER IN CONTRACT, STRICT LIABILITY, OR TORT (INCLUDING NEGLIGENCE OR OTHERWISE) ARISING IN ANY WAY OUT OF THE USE OF THIS SOFTWARE, EVEN IF ADVISED OF THE POSSIBILITY OF SUCH DAMAGE

```
=====
This product includes cryptographic software written by
Eric Young (eay@cryptsoft.com). This product includes
software written by Tim Hudson (tjh@cryptsoft.com).
*/
```

### Original SSLeay License

```
/*
Copyright (C) 1995-1998 Eric Young (eay@cryptsoft.com)
All rights reserved.
This package is an SSL implementation written by Eric
Young (eay@cryptsoft.com).
```

The implementation was written so as to conform with Netscapes SSL.

This library is free for commercial and non-commercial use as long as the following conditions are adhered to. The following conditions apply to all code found in this distribution, be it the RC4, RSA, lhash, DES, etc., code; not just the SSL code. The SSL documentation included with this distribution is covered by the same copyright terms except that the holder is Tim Hudson ([tjh@cryptsoft.com](mailto:tjh@cryptsoft.com)). Copyright remains Eric Young's, and as such any Copyright notices in the code are not to be removed.

If this package is used in a product, Eric Young should be given attribution as the author of the parts of the library used.

This can be in the form of a textual message at program startup or in documentation (online or textual) provided with the package.

Redistribution and use in source and binary forms, with or without modification, are permitted provided that the following conditions are met:

1. Redistributions of source code must retain the copyright notice, this list of conditions and the following disclaimer.
2. Redistributions in binary form must reproduce the above copyright notice, this list of conditions and the following disclaimer in the documentation and/or other materials provided with the distribution.
3. All advertising materials mentioning features or use of this software must display the following acknowledgement:  
"This product includes cryptographic software written by Eric Young (eay@cryptsoft.com)"  
The word 'cryptographic' can be left out if the rouines from the library being used are not cryptographic related :-).
4. If you include any Windows specific code (or a derivative thereof) from the apps directory (application code) you must include an acknowledgement:  
"This product includes software written by Tim Hudson ([tjh@cryptsoft.com](mailto:tjh@cryptsoft.com))"

THIS SOFTWARE IS PROVIDED BY ERIC YOUNG "AS IS" AND ANY EXPRESS OR IMPLIED WARRANTIES, INCLUDING, BUT NOT LIMITED TO, THE IMPLIED WARRANTIES OF MERCHANTABILITY AND FITNESS FOR A PARTICULAR PURPOSE ARE DISCLAIMED. IN NO EVENT SHALL THE AUTHOR OR CONTRIBUTORS BE LIABLE FOR ANY DIRECT, INDIRECT, INCIDENTAL, SPECIAL, EXEMPLARY, OR CONSEQUENTIAL DAMAGES (INCLUDING, BUT NOT LIMITED TO, PROCUREMENT OF SUBSTITUTE GOODS OR SERVICES; LOSS OF USE, DATA, OR PROFITS; OR BUSINESS INTERRUPTION) HOWEVER CAUSED AND ON ANY THEORY OF LIABILITY, WHETHER IN CONTRACT, STRICT LIABILITY, OR TORT (INCLUDING NEGLIGENCE OR OTHERWISE) ARISING IN ANY WAY OUT OF THE USE OF THIS SOFTWARE, EVEN IF ADVISED OF THE POSSIBILITY OF SUCH DAMAGE.

"The licence and distribution terms for any publically available version or derivative of this code cannot be changed. i.e. this code cannot simply be copied and put under another distribution licence [including the GNU Public Licence.]

**□ Exhibit-G  
LibJPEG**

In plain English:

1. We don't promise that this software works. (But if you find any bugs, please let us know!)
2. You can use this software for whatever you want. You don't have to pay us.
3. You may not pretend that you wrote this software. If you use it in a program, you must acknowledge somewhere in your documentation that you've used the IJG code.

In legalese:

The authors make NO WARRANTY or representation, either express or implied, with respect to this software, its quality, accuracy, merchantability, or fitness for a particular purpose.

This software is provided "AS IS", and you, its user, assume the entire risk as to its quality and accuracy.

This software is copyright (C) 1991-1998, Thomas G. Lane. All Rights Reserved except as specified below.

Permission is hereby granted to use, copy, modify, and distribute this software (or portions thereof) for any purpose, without fee, subject to these conditions:

- (1) If any part of the source code for this software is distributed, then this README file must be included, with this copyright and no-warranty notice unaltered; and any additions, deletions, or changes to the original files must be clearly indicated in accompanying documentation.
- (2) If only executable code is distributed, then the accompanying documentation must state that "this software is based in part on the work of the Independent JPEG Group".
- (3) Permission for use of this software is granted only if the user accepts full responsibility for any undesirable consequences; the authors accept NO LIABILITY for damages of any kind.

These conditions apply to any software derived from or based on the IJG code, not just to the unmodified library. If you use our work, you ought to acknowledge us. Permission is NOT granted for the use of any IJG author's name or company name in advertising or publicity relating to this software or products derived from it.

This software may be referred to only as "the Independent JPEG Group's software".

We specifically permit and encourage the use of this software as the basis of commercial products, provided that all warranty or liability claims are assumed by the product vendor.

ansi2knr.c is included in this distribution by permission of L. Peter Deutsch, sole proprietor of its copyright holder, Aladdin Enterprises of Menlo Park, CA.

ansi2knr.c is NOT covered by the above copyright and conditions, but instead by the usual distribution terms of the Free Software Foundation; principally, that you must include source code if you redistribute it. (See the file ansi2knr.c for full details.)

However, since ansi2knr.c is not needed as part of any program generated from the IJG code, this does not limit you more than the foregoing paragraphs do.

The Unix configuration script "configure" was produced with GNU Autoconf.

It is copyright by the Free Software Foundation but is freely distributable.

The same holds for its supporting scripts (config.guess, config.sub, ltconfig, ltmain.sh). Another support script, install-sh, is copyright by M.I.T. but is also freely distributable.

It appears that the arithmetic coding option of the JPEG spec is covered by patents owned by IBM, AT&T, and Mitsubishi.

Hence arithmetic coding cannot legally be used without obtaining one or more licenses.

For this reason, support for arithmetic coding has been removed from the free JPEG software.

(Since arithmetic coding provides only a marginal gain over the unpatented Huffman mode, it is unlikely that very many implementations will support it.)

So far as we are aware, there are no patent restrictions on the remaining code.

The IJG distribution formerly included code to read and write GIF files.

To avoid entanglement with the Unisys LZW patent, GIF reading support has been removed altogether, and the GIF writer has been simplified to produce uncompressed GIFs.

This technique does not use the LZW algorithm; the resulting GIF files are larger than usual, but are readable by all standard GIF decoders.

We are required to state that "The Graphics Interchange Format(c) is the Copyright property of CompuServe Incorporated. GIF(sm) is a Service Mark property of CompuServe Incorporated."

**□ Exhibit-H  
COPYRIGHT AND PERMISSION NOTICE**

Copyright (c) 1996 - 2008, Daniel Stenberg, <daniel@haxx.se>.

All rights reserved.

Permission to use, copy, modify, and distribute this software for any purpose with or without fee is hereby granted, provided that the above copyright notice and this permission notice appear in all copies.

THE SOFTWARE IS PROVIDED "AS IS", WITHOUT WARRANTY OF ANY KIND, EXPRESS OR IMPLIED, INCLUDING BUT NOT LIMITED TO THE WARRANTIES OF MERCHANTABILITY, FITNESS FOR A PARTICULAR PURPOSE AND NONINFRINGEMENT OF THIRD PARTY RIGHTS. IN NO EVENT SHALL THE AUTHORS OR COPYRIGHT HOLDERS BE LIABLE FOR ANY CLAIM, DAMAGES OR OTHER LIABILITY, WHETHER IN AN ACTION OF CONTRACT, TORT OR OTHERWISE, ARISING FROM, OUT OF OR IN CONNECTION WITH THE SOFTWARE OR THE USE OR OTHER DEALINGS IN THE SOFTWARE.

Except as contained in this notice, the name of a copyright holder shall not be used in advertising or otherwise to promote the sale, use or other dealings in this Software without prior written authorization of the copyright holder.

**□ Exhibit-I  
ICU License - ICU 1.8.1 and later**

COPYRIGHT AND PERMISSION NOTICE

Copyright (c) 1995-2010 International Business Machines Corporation and others

All rights reserved.

Permission is hereby granted, free of charge, to any person obtaining a copy of this software and associated documentation files (the "Software"), to deal in the Software without restriction, including without limitation the rights to use, copy, modify, merge, publish, distribute, and/or sell copies of the Software, and to permit persons to whom the Software is furnished to do so, provided that the above copyright notice(s) and this permission notice appear in all copies of the Software and that both the above copyright notice(s) and this permission notice appear in supporting documentation.

THE SOFTWARE IS PROVIDED "AS IS", WITHOUT WARRANTY OF ANY KIND, EXPRESS OR IMPLIED, INCLUDING BUT NOT LIMITED TO THE WARRANTIES OF MERCHANTABILITY, FITNESS FOR A PARTICULAR PURPOSE AND NONINFRINGEMENT OF THIRD PARTY RIGHTS. IN NO EVENT SHALL THE COPYRIGHT HOLDER OR HOLDERS INCLUDED IN THIS NOTICE BE LIABLE FOR ANY CLAIM, OR ANY SPECIAL INDIRECT OR CONSEQUENTIAL DAMAGES, OR ANY DAMAGES WHATSOEVER RESULTING FROM LOSS OF USE, DATA OR PROFITS, WHETHER IN AN ACTION OF CONTRACT, NEGLIGENCE OR OTHER TORTIOUS ACTION, ARISING OUT OF OR IN CONNECTION WITH THE USE OR PERFORMANCE OF THIS SOFTWARE.

Except as contained in this notice, the name of a copyright holder shall not be used in advertising or otherwise to promote the sale, use or other dealings in this Software without prior written authorization of the copyright holder. All trademarks and registered trademarks mentioned herein are the property of their respective owners.

**□ Exhibit-J**

Alternatively, this software may be distributed, used, and modified under the terms of BSD license:

Redistribution and use in source and binary forms, with or without modification, are permitted provided that the following conditions are met:

1. Redistributions of source code must retain the above copyright notice, this list of conditions and the following disclaimer.
2. Redistributions in binary form must reproduce the

above copyright notice, this list of conditions and the following disclaimer in the documentation and/or other materials provided with the distribution.

3. Neither the name(s) of the above-listed copyright holder(s) nor the names of its contributors may be used to endorse or promote products derived from this software without specific prior written permission.

THIS SOFTWARE IS PROVIDED BY THE COPYRIGHT HOLDERS AND CONTRIBUTORS AS IS AND ANY EXPRESS OR IMPLIED WARRANTIES, INCLUDING, BUT NOT LIMITED TO, THE IMPLIED WARRANTIES OF MERCHANTABILITY AND FITNESS FOR A PARTICULAR PURPOSE ARE DISCLAIMED. IN NO EVENT SHALL THE COPYRIGHT OWNER OR CONTRIBUTORS BE LIABLE FOR ANY DIRECT, INDIRECT, INCIDENTAL, SPECIAL, EXEMPLARY, OR CONSEQUENTIAL DAMAGES (INCLUDING, BUT NOT LIMITED TO, PROCUREMENT OF SUBSTITUTE GOODS OR SERVICES; LOSS OF USE, DATA, OR PROFITS; OR BUSINESS INTERRUPTION) HOWEVER CAUSED AND ON ANY THEORY OF LIABILITY, WHETHER IN CONTRACT, STRICT LIABILITY, OR TORT (INCLUDING NEGLIGENCE OR OTHERWISE) ARISING IN ANY WAY OUT OF THE USE OF THIS SOFTWARE, EVEN IF ADVISED OF THE POSSIBILITY OF SUCH DAMAGE.

**□ Exhibit-K  
COPYRIGHT**

Copyright 1992, 1993, 1994, 1997 Henry Spencer. All rights reserved.

This software is not subject to any license of the American Telephone and Telegraph Company or of the Regents of the University of California.

Permission is granted to anyone to use this software for any purpose on any computer system, and to alter it and redistribute it, subject to the following restrictions:

1. The author is not responsible for the consequences of use of this software, no matter how awful, even if they arise from flaws in it.
2. The origin of this software must not be misrepresented, either by explicit claim or by omission. Since few users ever read sources, credits must appear in the documentation.
3. Altered versions must be plainly marked as such, and must not be misrepresented as being the original software. Since few users ever read sources, credits must appear in the documentation.
4. This notice may not be removed or altered

**□ Exhibit-L**

/\*\*\*\*\*\*

The author of this software is David M. Gay. Copyright (c) 1991, 2000, 2001 by Lucent Technologies.

Permission to use, copy, modify, and distribute this software for any purpose without fee is hereby granted, provided that this entire notice is included in all copies of any software which is or includes a copy or modification of this software and in all copies of the supporting documentation for such software.

THIS SOFTWARE IS BEING PROVIDED "AS IS", WITHOUT ANY EXPRESS OR IMPLIED WARRANTY. IN PARTICULAR, NEITHER THE AUTHOR NOR LUCENT MAKES ANY REPRESENTATION OR WARRANTY OF ANY KIND CONCERNING THE MERCHANTABILITY OF THIS SOFTWARE OR ITS FITNESS FOR ANY PARTICULAR PURPOSE.

\*\*\*\*\*/

## **License Information for the Software Used in the Unit**

---

### **About GPL (GNU-General Public License), LGPL (GNU Lesser General Public License) License**

This product uses GPL/LGPL software and software made by other companies.

After you purchase this product, you may procure, modify or distribute the source code of the GPL/LGPL software that is used in the product.

DENON provides the source code based on the GPL and LPGL licenses at the actual cost upon your request to our customer service center. However, note that we make no guarantees concerning the source code. Please also understand that we do not offer support for the contents of the source code.

**DENON**

[www.denon.com](http://www.denon.com)

D&M Holdings Inc.  
Printed in China 5411 10460 11AD